



## IBZ REPLACEMENT PARTS LIST





**For individual spec sheets and installation instructions please see the replacement parts page and the installation page for the IBZ on [Acuitybrands.com](http://Acuitybrands.com)**





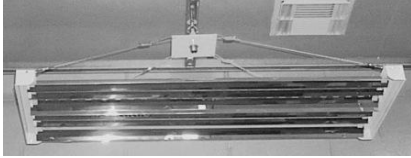

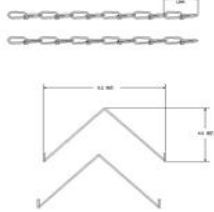
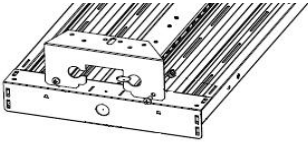

### Sensor Switch Motion Sensor Replacements





Nomenclature	Description	Photo	Ci code
<b>RK1 MSI360 U</b>	Sensorswitch sensor - 360° sensing, 120/277 volt (CMRB 6)		<b>*138CE0</b>
<b>RK1 MSI360 480 U</b>	Sensorswitch sensor - 360° sensing, 480 volt (CMRB 6)		<b>*209NXF</b>
<b>RK1 MSI U</b>	Sensorswitch sensor - Aisle sensing, 120/277 volt (CMRB 50)		<b>*138CE1</b>
<b>RK1 MSI 480 U</b>	Sensorswitch sensor - Aisle sensing, 480 volt (CMRB 50)		<b>*138CE1</b>
<b>Part Number U02201</b>	Internal sensor cover		<b>*212JRF</b>

### IBZ Mounting Hardware Replacements

<b>IBAC120 M20</b>	10' adjustable aircraft cable, 2-hook, Y hanger (No.2) (Master pack of 20)		<b>*163AMF</b>
<b>IBAC240 M20</b>	20' adjustable aircraft cable, 2-hook, Y hanger (No.2) (Master pack of 20)		<b>*163AMG</b>

<b>IBHMP</b>	Hook monopoint		<b>*121PFN</b>
<b>IBZPMP</b>	Pendant monopoint splice box, includes side covers. (2-ballast configuration recommended 2/2)		<b>*198X42</b>
<b>IBZPMPHB</b>	Pendant monopoint splice box, includes side covers. (3/4" HUB) (2-ballast configuration recommended 2/2)		<b>*204N94</b>
<b>HBBS36</b>	Chain hanger, 36" (one pair)		<b>*145GK8</b>
<b>IBZSMB</b>	Surface-mounting bracket (one pair) Not usable for fixtures with backpack option (extra ballasts or emergency packs)		<b>*202GX0</b>
<b>IBZACVH</b>	Aircraft cable and "V" hook (one pair)		<b>*202A56</b>
<b>IBZ Reflectors</b>			

<b>IBZR4</b>	4-Lamp - ND specular reflector - Order 2 reflectors per fixture		<b>*208W2H</b>
<b>IBZR4 NDU</b>	4-Lamp - NDU specular reflector with uplight - Order 2 reflectors per fixture		<b>*209TNH</b>
<b>IBZR4 WD</b>	4-Lamp - WD white wide distribution reflector - Order 2 reflectors per fixture		<b>*210XRY</b>
<b>IBZR4 WDU</b>	4-Lamp - WD white wide distribution reflector with uplight- Order 2 reflectors per fixture		<b>*210K3Y</b>
<b>IBZR6</b>	6-Lamp - ND specular reflector - Order 2 reflectors per fixture		<b>*208LTA</b>
<b>IBZR6 NDU</b>	6-Lamp - NDU specular reflector with uplight - Order 2 reflectors per fixture		<b>*208F76</b>
<b>IBZR6 WD</b>	6-Lamp - WD white wide distribution reflector - Order 2 reflectors per fixture		<b>*207N9J</b>
<b>IBZR6 WDU</b>	6-Lamp - WD white wide distribution reflector with uplight- Order 2 reflectors per fixture		<b>*212JCE</b>

<b>IBZR8</b>	8-Lamp - ND specular reflector - Order 2 reflectors per fixture		<b>*211ALA</b>
<b>IBZR8 NDU</b>	8-Lamp - NDU specular reflector with uplight - Order 2 reflectors per fixture		
<b>IBZR8 WD</b>	8-Lamp - WD white wide distribution reflector - Order 2 reflectors per fixture		<b>*229RXY</b>
<b>IBZR8 WDU</b>	8-Lamp - WD white wide distribution reflector with uplight- Order 2 reflectors per fixture		

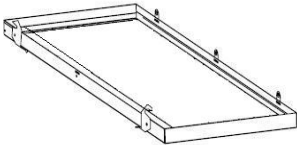

### IBZ Shielding

#### A12125

<b>DLIBZ14 A12125</b>	4-lamp fixture door assembly with pattern 12 acrylic lens, .125" thick		<b>*203T2V</b>
<b>DLIBZ19 A12125</b>	6-lamp fixture door assembly with pattern 12 acrylic lens, .125" thick		<b>*199LH2</b>
<b>DLIBZ24 A12125</b>	8-lamp fixture door assembly with pattern 12 acrylic lens, .125" thick		<b>*204XMP</b>

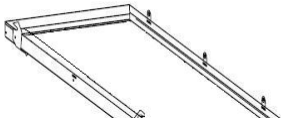
#### ACL

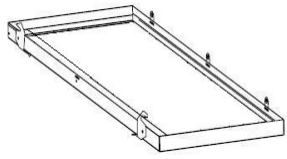
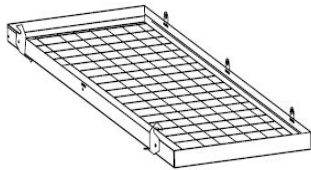
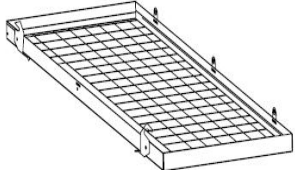
<b>DLIBZ14 ACL</b>	4-lamp fixture door assembly with clear acrylic lens, .125" thick		<b>*200NU8</b>
<b>DLIBZ19 ACL</b>	6-lamp fixture door assembly with clear acrylic lens, .125" thick		<b>*200C99</b>

<b>DLIBZ24 ACL</b>	8-lamp fixture door assembly with clear acrylic lens, .125" thick		<b>*200NU9</b>
<b>PCL125</b>			
<b>DLIBZ14 PCL125</b>	4-lamp fixture door assembly with clear acrylic lens, .125" thick		<b>*202TLW</b>
<b>DLIBZ19 PCL125</b>	6-lamp fixture door assembly with clear acrylic lens, .125" thick		<b>*202TLX</b>
<b>DLIBZ24 PCL125</b>	8-lamp fixture door assembly with clear acrylic lens, .125" thick		<b>*204WML</b>
<b>A12125WG</b>			
<b>DLIBZ14 A12125WG</b>	4-lamp fixture door assembly with pattern 12 acrylic lens, .125" thick, and wireguard		<b>*211GAW</b>
<b>DLIBZ19 A12125WG</b>	6-lamp fixture door assembly with pattern 12 acrylic lens, .125" thick with wireguard		
<b>DLIBZ24 A12125WG</b>	8-lamp fixture door assembly with pattern 12 acrylic lens, .125" thick with wireguard		
<b>ACLWG</b>			
<b>DLIBZ14 ACLWG</b>	4-lamp fixture door assembly with pattern 12 acrylic lens, .125" thick, and wireguard		<b>*202G9N</b>
<b>DLIBZ19 ACLWG</b>	6-lamp fixture door assembly with pattern 12 acrylic lens, .125" thick with wireguard		<b>*203M8V</b>
<b>DLIBZ24 ACLWG</b>	8-lamp fixture door assembly with pattern 12 acrylic lens, .125" thick with wireguard		<b>*210RJH</b>
<b>NLWG</b>			
<b>DLIBZ14 NLWG</b>	4-lamp fixture door assembly with pattern 12 acrylic lens, .125" thick, and wireguard		

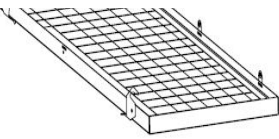
<b>DLIBZ19 NLWG</b>	6-lamp fixture door assembly with pattern 12 acrylic lens, .125" thick with wireguard		
<b>DLIBZ24 NLWG</b>	8-lamp fixture door assembly with pattern 12 acrylic lens, .125" thick with wireguard		

**8 FOOT FIXTURE DOOR ASSEMBLIES REQUIRE A LEFT/RIGHT DOOR**

**A12125**

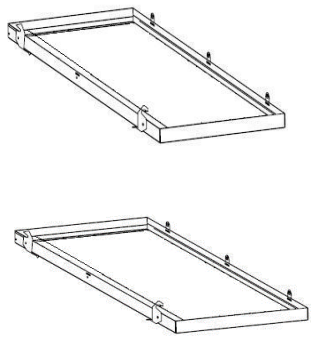
<b>DLIBZ14L A12125</b> <b>DLIBZ14R A12125</b>	4-lamp fixture door assembly with pattern 12 acrylic lens, .125" thick		
<b>DLIBZ19L A12125</b> <b>DLIBZ19R A12125</b>	6-lamp fixture door assembly with pattern 12 acrylic lens, .125" thick		
<b>DLIBZ24L A12125</b> <b>DLIBZ24R A12125</b>	8-lamp fixture door assembly with pattern 12 acrylic lens, .125" thick		

**ACL**

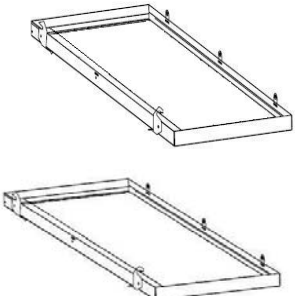
<b>DLIBZ14L ACL</b> <b>DLIBZ14R ACL</b>	4-lamp fixture door assembly with pattern 12 acrylic lens, .125" thick		
<b>DLIBZ19L ACL</b> <b>DLIBZ19R ACL</b>	6-lamp fixture door assembly with pattern 12 acrylic lens, .125" thick		
<b>DLIBZ24L ACL</b> <b>DLIBZ24R ACL</b>	8-lamp fixture door assembly with pattern 12 acrylic lens, .125" thick		

**PCL125**

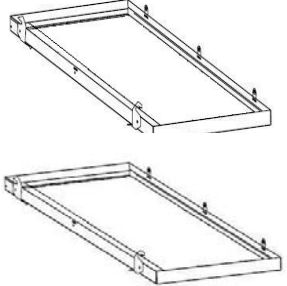
<b>DLIBZ14L PCL125</b> <b>DLIBZ14R PCL125</b>	4-lamp fixture door assembly with pattern 12 acrylic lens, .125" thick		
<b>DLIBZ19L PCL125</b> <b>DLIBZ19R PCL125</b>	6-lamp fixture door assembly with pattern 12 acrylic lens, .125" thick		
<b>DLIBZ24L PCL125</b> <b>DLIBZ24R PCL125</b>	8-lamp fixture door assembly with pattern 12 acrylic lens, .125" thick		

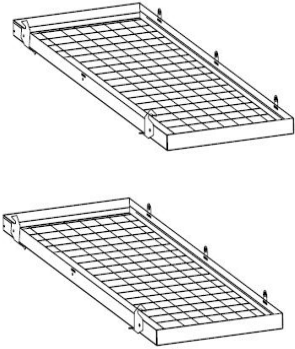

**A12125WG**

<b>DLIBZ14L A12125WG</b> <b>DLIBZ14R A12125WG</b>	4-lamp fixture door assembly with pattern 12 acrylic lens, .125" thick and wireguard.		
<b>DLIBZ19L A12125WG</b> <b>DLIBZ19R A12125WG</b>	6-lamp fixture door assembly with pattern 12 acrylic lens, .125" thick and wireguard		
<b>DLIBZ24L A12125WG</b> <b>DLIBZ24R A12125WG</b>	8-lamp fixture door assembly with pattern 12 acrylic lens, .125" thick and wireguard		

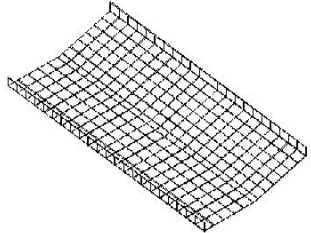



**EXTERNAL WIREGUARD**

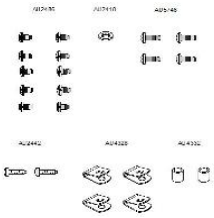

<b>WGIBZ14</b>	External wireguard for standard 4-lamp IBZ (order two for 8 foot fixtures)		<b>*201HT4</b>
<b>WGIBZ19</b>	External wireguard for standard 6-lamp IBZ (order two for 8 foot fixtures)		<b>*200F4A</b>
<b>WGIBZ24</b>	External wireguard for standard 8-lamp IBZ (order two for 8 foot fixtures)		<b>*202JRY</b>

**IBZ SOCKETS**

<b>W238</b>	PBT Sockets for the T8 fixtures - instant start		<b>*221HV5</b>
<b>W239</b>	PBT Sockets for the T8 fixtures - Program start		
<b>W246</b>	PBT Sockets for T5 fixtures		<b>*219KRH</b>

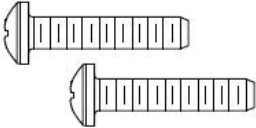
**MISCELLANEOUS PARTS**

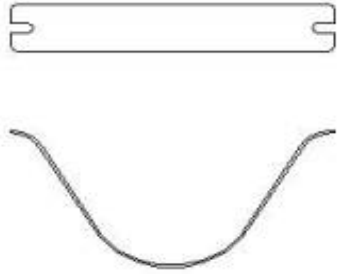
<p><b>IBZWG HDW M25</b></p>	<p>IBZ wireguard hardware bag</p>		<p><b>*205J5H</b></p>
<p><b>IBZ DOOR HDWE M25</b></p>	<p>IBZ door hardware bag</p>		<p><b>*205J5G</b></p>
<p><b>O9930</b></p>	<p>Back access plate</p>		<p><b>*212L92</b></p>
<p><b>RKIBZ 4LAMP MVOLT</b></p>	<p>IBZ cool running plus ballast - 4-lamp ballast. IOP - original cool running plus ballast. Replaced in March 2011 with the ICRP</p>		<p><b>*203MXN</b></p>
<p><b>RKIBZ 2LAMP MVOLT</b></p>	<p>IBZ cool running plus ballast - 2-lamp ballast. IOP - original cool running plus ballast. Replaced in March 2011 with the ICRP</p>		<p><b>*203MXP</b></p>
<p><b>B02705</b></p>	<p>Ballast channel cover</p>		<p><b>*212J2C</b></p>
<p><b>None</b></p>	<p>Ballast channel cover screw</p>		<p><b>Order part number AU2486 Order 2 per fixture</b></p>
<p><b>IBZFSP</b></p>	<p>Full side panels</p>		<p><b>*203U3A</b></p>

<p><b>AU1576</b></p>	<p>Lens clip - (10 per fixture) Holds the lens flat in the door frame rail.</p>		<p>Order part number <b>AU1576</b>. Order the number of clips you need. The part number is for one clip.</p>
<p><b>B1624</b></p>	<p>Side covers for the PMP or the HBPMP</p>		<p>Order part number <b>B1624</b>. Order the number of covers you need. The part number is for one cover.</p>