



ZOHO™

6TH GEN
Area Light



SKU #	DLC Model #
156834	BLT-S-G12C-300WBT3DA2-BH10SP40/50/57W
156752-1	BLT-S-G12-150WBT3SA2-BR10SP40/50/57W
157263	BLT-S-G12C-150WBT3DH1-BR10SP40/50/57W
156838-1	BLT-S-G12-150WBT3SA2-BR10SP40/50/57W
156796-1	BLT-S-G12C-300WBT3DA2-BH10SP40/50/57W
156800-1	BLT-S-G12C-300WBT3DA2-BH10SP40/50/57W
157218	BLT-S-G12C-300WBT3DH1-BR10SP40/50/57W

The Zoho 6th Generation Area Light from Beyond LED Technology is a trusted, high-performance outdoor lighting solution, built for durability and designed with a slim, modern profile. Delivering up to 170 lumens per watt, it ensures superior energy efficiency while offering adjustable wattage and CCT for flexible project customization. Constructed from rugged die-cast aluminum and finished in a sleek bronze housing, the Zoho 6th Gen combines top-tier performance with contemporary aesthetics. A universal mounting bracket allows for quick, hassle-free installation—perfect for parking lots, loading docks, and general area lighting.

ZOHO™

6TH GEN

Area Light



Product Features

- Up to 170 lm/W
- Adjustable wattage
- Adjustable CCT
- Optional screw-in photocell
- 0-10V Dimmable
- Built-in 10KV surge protector
- Universal Bracket Included
- Die-cast aluminum housing
- White, Black & Bronze housing
- Input Voltage 120-277VAC/277-480VAC
- UL & DLC listed
- 5-Year warranty

SKU	MODEL NUMBER	ADJUSTABLE WATT	MAX LUMENS	ADJ CCT	INPUT VOLTAGE	DISTRIBUTION	SENSOR BASE	DIMMING	HOUSING	IP RATING	CERTIFICATIONS
156752-1	BLT-S-G12-150WB T3SA2-BR10SP40/50/57W	100W/120W/ 150W	25500	4000K/ 5000K/ 5700K	120-277V	Type III	Yes	0-10V	Bronze	IP65	UL & DLC
156838-1	BLT-S-G12-150WB T3SA2-BR10SP40/50/57W	100W/120W/ 150W	25500		120-277V				Black		
157263	BLT-S-G12C-150WBT3 DH1-BR10SP40150157W	100W/120W/ 150W	25500		277-480V				Bronze		
156834	BLT-S-G12C-300WB T3DA2-BH10SP40/50/57W	200W/240W/ 300W	49800		120-277V		No		White		
156796-1	BLT-S-G12C-300WB T3DA2-BH10SP40/50/57W	200W/240W/ 300W	49800		120-277V		Yes		Bronze		
156800-1	BLT-S-G12C-300WB T3DA2-BH10SP40/50/57W	200W/240W/ 300W	49800		120-277V				Black		
157218	BLT-S-G12C-300WB T3DH1-BR10SP40/50/57W	200W/240W/ 300W	49800		277-480V				Bronze		



ZOHO

6TH GEN
Area Light

SKU: 156752-1 / 156838-1

Specifications

With 3-Pin Sensor Receptacle

Parameter	Description	Value
General Performance	Adjustable Watt	100W / 120W / 150W
	Max Lumens	25500
	Lumen Efficacy	Up to 170LM/W
	Color Temperature	4000K / 5000K / 5700K
	CRI (Ra)	>80
	Light Spread	150 * 90°
	Distribution Pattern	Type III
Electrical	Input Voltage	120-277Vac
	Frequency	50/60Hz
	Dimming	0-10V Dimmable
	PF	≥0.9
	Driver Brand	Beyond
	Driver Model	SS-160NH-E260BH
	Surge Protector	L/N-PE: 10kV, L-N: 10kV
Physical	Operating Temperature	Without Motion Sensor: -40°C TO 50°C; With Motion Sensor: -30°C TO 50°C
	Storage Temperature	-40°C TO 80°C
	Operating Humidity	20% - 90% RH
	Storage Humidity	10% - 95% RH
	LED Brand	Lumileds
	LED Type	SMD2835
	LED QTY	364 Pcs
Construction	Die-cast aluminum	
Qualification	Housing Color	Bronze / Black
	IP Rating	IP65
	Warranty	5 Years

ZOHO™

6TH GEN

Area Light



SKU: 157263

Specifications

With 3-Pin Sensor Receptacle

Parameter	Description	Value
General Performance	Adjustable Watt	100W / 120W / 150W
	Max Lumens	25500
	Lumen Efficacy	Up to 170LM/W
	Color Temperature	4000K / 5000K / 5700K
	CRI (Ra)	>80
	Light Spread	150 * 90°
	Distribution Pattern	Type III
Electrical	Input Voltage	277-480Vac
	Frequency	50/60Hz
	Dimming	0-10V Dimmable
	PF	≥0.9
	Driver Brand	Sosen
	Driver Model	SS-160NH-E260BH
	Surge Protector	L/N-PE: 10kV, L-N: 10kV
Physical	Operating Temperature	Without Motion Sensor: -40°C TO 50°C; With Motion Sensor: -30°C TO 50°C
	Storage Temperature	-40°C TO 80°C
	Operating Humidity	20% - 90% RH
	Storage Humidity	10% - 95% RH
	LED Brand	Lumileds
	LED Type	SMD2835
	LED QTY	364*2 Pcs
	Construction	Die-cast aluminum
Qualification	Housing Color	Bronze
	IP Rating	IP65
	Warranty	5 Years

AREA LIGHT



ZOHO

6TH GEN
Area Light

SKU: 156834

Specifications

Parameter	Description	Value
General Performance	Adjustable Watt	200W / 240W / 300W
	Max Lumens	49800
	Lumen Efficacy	Up to 170LM/W
	Color Temperature	4000K / 5000K / 5700K
	CRI (Ra)	>80
	Light Spread	155 * 85°
	Distribution Pattern	Type III
	Input Voltage	120-277V
Electrical	Frequency	50/60Hz
	Dimming	0-10V Dimmable
	PF	≥0.9
	THD (Tolerance: +5%)	≤20%
	Flicker Percent	<5%
	Driver Brand	Beyond
	Driver Model	R1-V320B-260B12
	Surge Protector	L/N-PE: 10kV, L-N: 10kV
Physical	Operating Temperature	Without Motion Sensor: -40°C TO 50°C; With Motion Sensor: -35°C TO 50°C
	Storage Temperature	-40°C TO 80°C
	Operating Humidity	20% - 90% RH
	Storage Humidity	10% - 95% RH
	LED Brand	Lumileds
	LED Type	SMD2835
	LED QTY	728 Pcs
	Construction	Die-cast aluminum
Qualification	Housing Color	White
	IP Rating	IP65
	Warranty	5 Years

ZOHO™

6TH GEN

Area Light



SKU: 156796-1/156800-1

Specifications

With 3-Pin Sensor Receptacle

Parameter	Description	Value
General Performance	Adjustable Wattage	200W / 240W / 300W
	Max Lumens	49800
	Lumen Efficacy	Up to 170LM/W
	Color Temperature	4000K / 5000K / 5700K
	CRI (Ra)	>80
	Light Spread	150 * 90°
	Distribution Pattern	Type III
	Input Voltage	120-277Vac
Electrical	Frequency	50/60Hz
	Dimming	0-10V Dimmable
	PF	≥0.9
	THD (Tolerance: -3%)	≤20%
	Flicker Percent	<5%
	Driver Brand	Beyond
	Driver Model	SS-320NH-E260BH
	Surge Protector	L/N-PE: 10kV, L-N: 10kV
Physical	Operating Temperature	Without Motion Sensor: -40°C TO 50°C; With Motion Sensor: -35°C TO 50°C
	Storage Temperature	-40°C TO 80°C
	Operating Humidity	20% - 90% RH
	Storage Humidity	10% - 95% RH
	LED Brand	Lumileds
	LED Type	SMD2835
	LED QTY	728 Pcs
	Construction	Die-cast aluminum
Qualification	Housing Color	Bronze / Black
	IP Rating	IP65
	Warranty	5 Years

AREA LIGHT



ZOHO

6TH GEN
Area Light

SKU: 157218

Specifications

With 3-Pin Sensor Receptacle

Parameter	Description	Value
General Performance	Adjustable Wattage	200W / 240W / 300W
	Max Lumens	49800
	Lumen Efficacy	Up to 170LM/W
	Color Temperature	4000K / 5000K / 5700K
	CRI (Ra)	>80
	Light Spread	150 * 85°
	Distribution Pattern	Type III
Electrical	Input Voltage	277-480V
	Frequency	50/60Hz
	Dimming	0-10V Dimmable
	PF	≥0.9
	THD (Tolerance: -3%)	≤20%
	Flicker Percent	<5%
	Driver Brand	Beyond
Physical	Driver Model	SS-320NH-E260BH
	Surge Protector	L/N-PE: 10kV, L-N: 10kV
	Operating Temperature	Without Motion Sensor: -40°C TO 50°C; With Motion Sensor: -35°C TO 50°C
	Storage Temperature	-40°C TO 80°C
	Operating Humidity	20% - 90% RH
	Storage Humidity	10% - 95% RH
	LED Brand	Lumileds
Qualification	LED Type	SMD2835
	LED QTY	728 Pcs
	Construction	Die-cast aluminum
Qualification	Housing Color	Bronze
	IP Rating	IP65
	Warranty	5 Years

ZOHO™

6TH GEN

Area Light



Correlated Color Temperature (CCT)

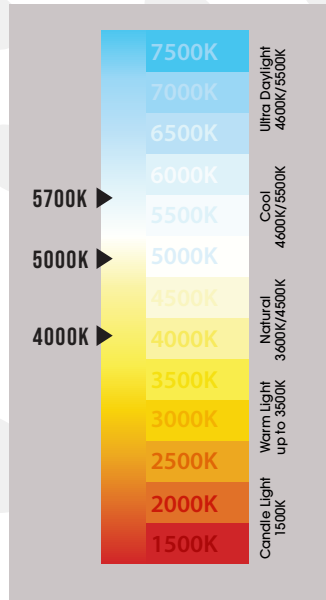

Optional Photocell



SKU: 110786

Wattage & CCT Adjustable

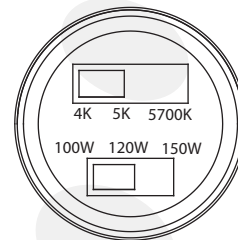

Dimensions

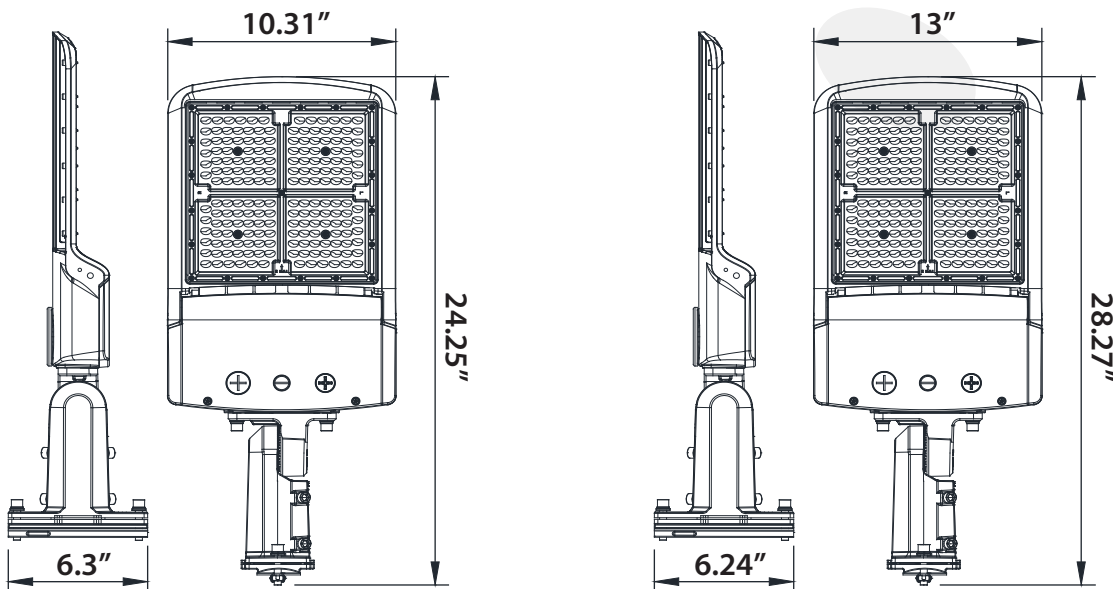



ZOHO

6TH GEN
Area Light

150 Watt

Distribution Curve

Luminaire Property

Luminaire Manufacturer:
Luminaire Category:
Lamp Catalog:
Number of Lamps:
Luminous Length (mm):
Luminous Height (mm):
Current: 1.253 A
Power Factor: 0.999

Luminaire Description:
Lamp Description:
Lumens per Lamp:
Luminous Width (mm):
Voltage: 120.0 V
Power: 150.15 W

Photometric Results

IES Classification: Type III
Total Rated Lamp Lumens: 23668.1 lm
Efficiency: 100%
Upward Ratio: 0%
C0r0 Intensity: 5220.27 cd
Pos of Max. Intensity: H180 V66
Beam Angle(C0/C180,C90/C270,C45/C225,C135/315): 155.7, 96.5, 136.9, 136.0

Longitudinal Classification: Short
Measurement Flux: 23668.1 lm
Downward Ratio: 100%
Luminaire Efficacy Rating (LER): 157.68
Max. Intensity: 8172.74 cd

Luminous Intensity Distribution Curve

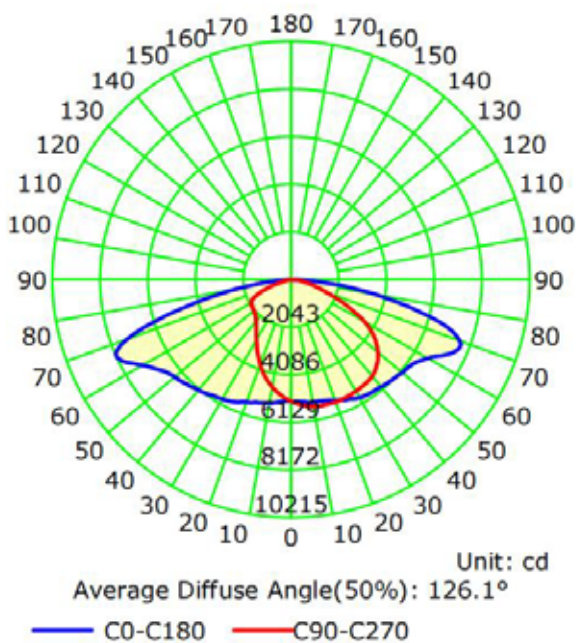

The Average Illuminance Effective Figure

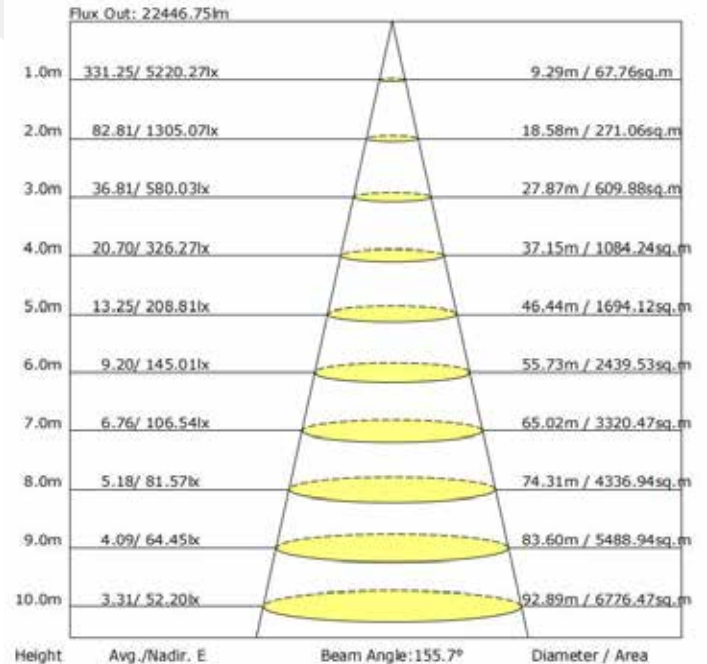

ZOHO™

6TH GEN

Area Light



300 Watt

Distribution Curve

Luminaire Property

Luminaire Manufacturer:
 Luminaire Category:
 Lamp Catalog:
 Number of Lamps:
 Luminous Length (mm):
 Luminous Height (mm):
 Current: 2.553 A
 Power Factor: 0.994

Luminaire Description:
 Lamp Description:
 Lumens per Lamp:
 Luminous Width (mm):
 Voltage: 120.0 V
 Power: 304.57 W

Photometric Results

IES Classification: Type III
 Total Rated Lamp Lumens: 46524.3 lm
 Efficiency: 100%
 Upward Ratio: 0%
 C0r0 Intensity: 10988.01 cd
 Pos of Max. Intensity: H157.5 V65
 Beam Angle(C0/C180,C90/C270,C45/C225,C135/315): 153.3, 85.7, 140.3, 115.2

Longitudinal Classification: Short
 Measurement Flux: 46524.3 lm
 Downward Ratio: 100%
 Luminaire Efficacy Rating (LER): 152.80
 Max. Intensity: 14601.09 cd

Luminous Intensity Distribution Curve

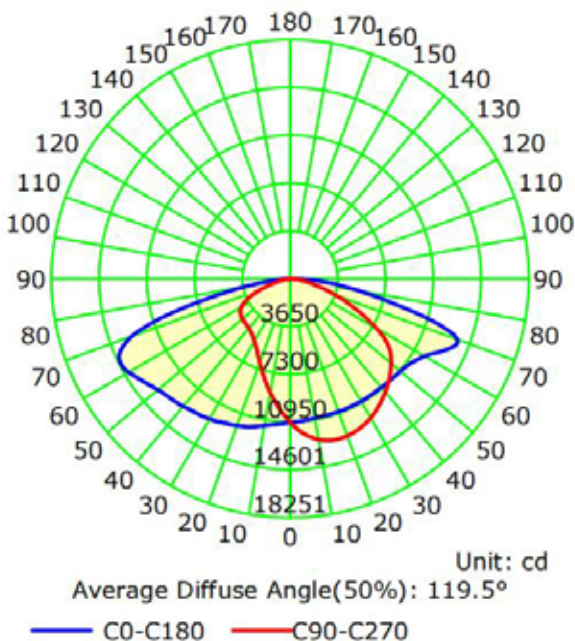

The Average Illuminance Effective Figure

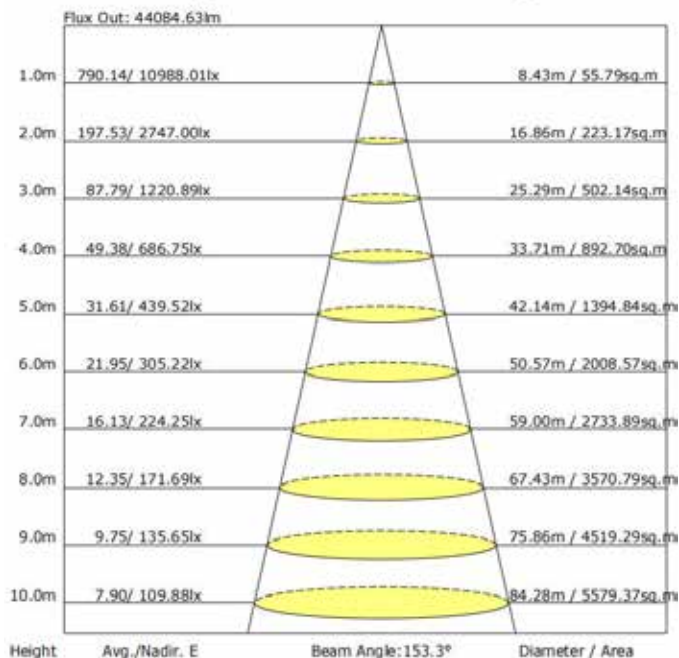

AREA LIGHT



ZOHO

6TH GEN

Area Light

Installation

Cautions:

1. Can not use the electric generator to test the LED lamp.
2. Please abide by related country, regional and local law and regulations when install this fixture.
3. To avoid electrical shock and damage, please do not install the lights in raining days.

Notices:

1. To prevent from electric shock or fire risk, the installation must be conducted by operator who have professional electrical knowledge.
2. Please wear gloves to avoid injury before installing lamps.
3. During or after installation, if there are situations such as smoke, fire in the wires or lam please turn off the power immediately and notify relevant personnel of an overhaul.
4. This light can be used for outdoor installation.

Instructions:

1. This product has dimming and non-dimming function, which differs in installation ways.
2. 3 dimming functions are available in this shoebox light:
 - (1). Constant current can be achieved by 0-10VDC dimming.
 - (2). PWM signal dimming.
 - (3). Variation of resistance unit dimming (Please choose the appropriate dimming way according to your needs. You can also choose not to use this function).
3. Choose the wire connection ways, dimming ways and installation ways according to your needs and the led fixture purchased.

Wiring Diagram:

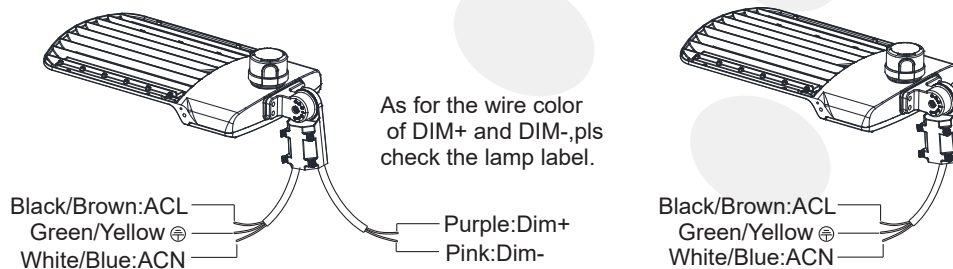

Optional Brackets and Installation Instructions

There are 5 optional brackets for this fixture. The following is shoebox fixtures with different brackets

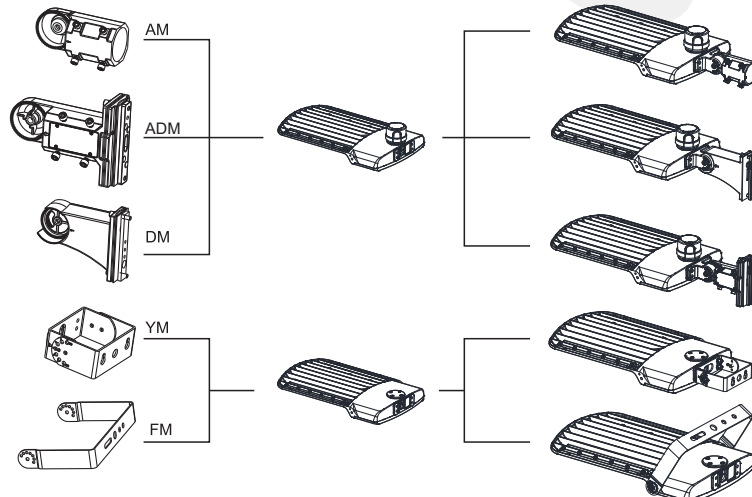

ZOHO™

6TH GEN

Area Light



Installation

Installation Instructions with different brackets:

1. ADJUSTABLE FITTER MOUNTING (AM)

Step 1: Remove the bracket mounting screws on the fixture and run the wires through the bracket. (Figure 1)

Step 2: Install the bracket on the fixture. (Figure 2)

2. ADJUSTABLE FITTER MOUNTING & DIRECT MOUNTING (ADM)

Step 1: Remove the bracket mounting screws on the fixture, open the side lid of bracket and run the wires through the bracket. (Figure 3)

Step 2: Install the bracket on the fixture, then cover the side lid and tighten it. (Figure 4)

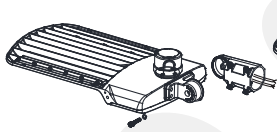

Figure 1

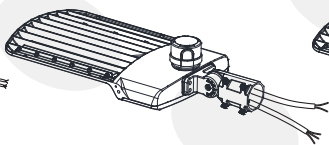

Figure 2

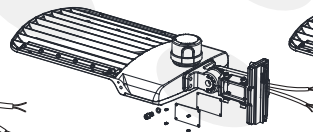

Figure 3

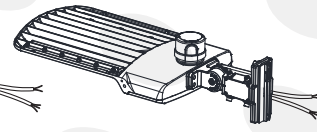

Figure 4

3. DIRECT MOUNTING (DM)

Step 1: Remove the bracket mounting screws on the fixture, open the side lid of bracket and run the wires through the bracket. (Figure 5)

Step 2: Install the bracket on the fixture, then cover the side lid and tighten it. (Figure 6)

4. YOKE MOUNTING (YM)

Step 1: Remove the bracket mounting screws on the fixture and run the wires through the bracket. (Figure 7)

Step 2: Install the bracket on the fixture. (Figure 8)

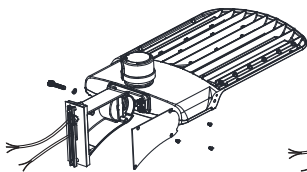

Figure 5

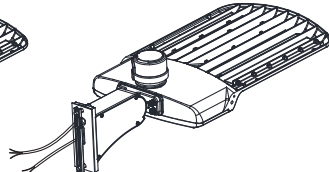

Figure 6

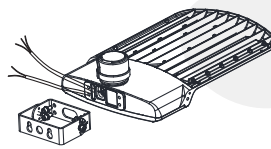

Figure 7

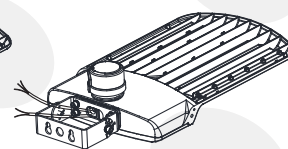

Figure 8

5. FLOOD MOUNTING (FM)

Step 1: First install two big screwst. (Figure 9)

Step 2: Install two small screws. (Figure 10)

Installation of LED Lamps:

1. ADJUSTABLE FITTER MOUNTING (AM)

Step 1: Loosen the four bolts on AM bracket, connect the wires correctly, and pull the wires into the poles. (Figure 11)

Step 2: Place the bracket into the pole and lock the four bolts. (Figure 12)

Notice: Adjustable angle is 0-90° (Figure 11)

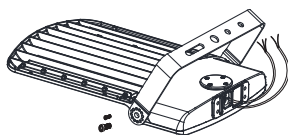

Figure 9

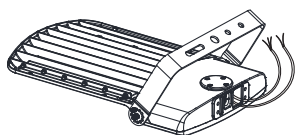

Figure 10

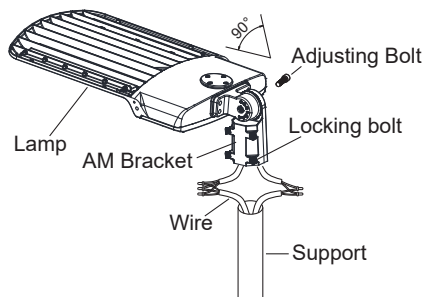

Figure 11

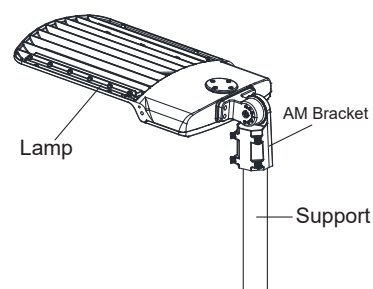

Figure 12



ZOHO

6TH GEN

Area Light

Installation

2. ADJUSTABLE FITTER MOUNTING & DIRECT MOUNTING (ADM)

2.1 ADJUSTABLE FITTER MOUNTING

Step 1: Remove the spare parts from ADM bracket. (Figure 13).

Step 2: Loosen the four bolts on ADM bracket, connect the wires correctly and pull the wires into the poles. (Figure 14)

Step 3: Place the bracket into the pole and lock the four bolts. (Figure 14)

Notice: Adjustable angle is 0-90°(Figure 14)

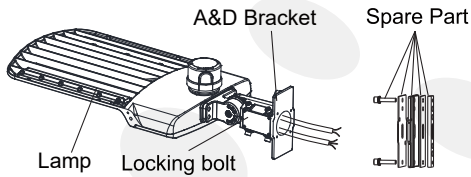

Figure 13

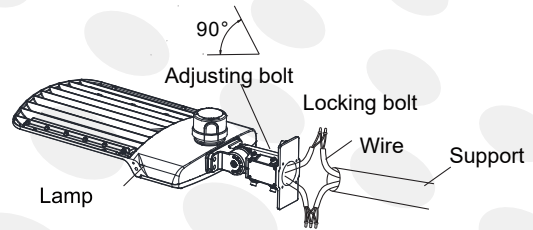

Figure 14

2.2 DIRECT MOUNTING

Step 1: Remove the four bolts from ADM bracket, remove the four rubber plugs from installation bar, put the four rubber plugs on the place where the four bolts were previously placed on the bracket for waterproof purpose (Figure 15)

Step 2: Fix ADM bracket to square pole with bolt, open the cover of ADM bracket junction box, pull the wire into bracket junction box, connect the wire properly and cover the junction box. (Figure 16)

Notice: Adjustable angle is 0-90°. (Figure 16)

Same as round pole installation, please remember to use the adapting plate for round pole installation (Figure 17)

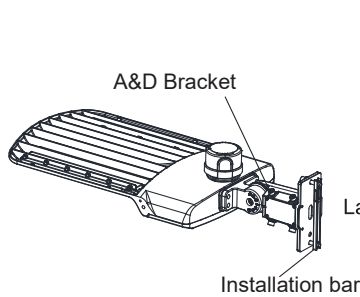

Figure 15

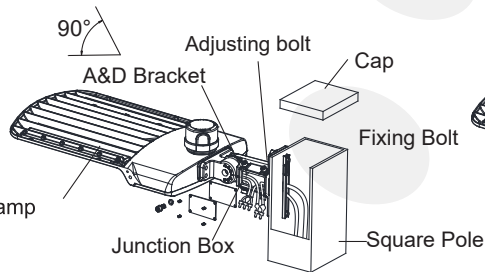

Figure 16

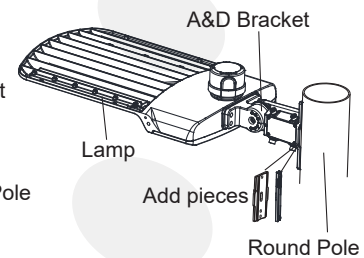

Figure 17

3. DIRECT MOUNTING (DM)

Step 1: Fix DM bracket to square pole with bolt, open the side lid of DM bracket, pull the wire into junction box, and connect the wire correctly. (Figure 18)

Step 2: Put the connected wire into the junction box, then cover the junction box. (Figure 19)

Notice: Adjustable angle is 0-35°(Figure 18).

Same as round pole installation, please remember to remove the silicon plate when install the fixture in round pole (Figure 20)

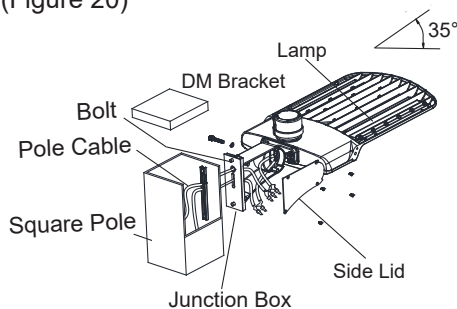

Figure 18

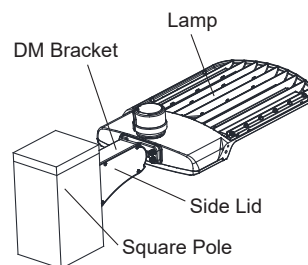

Figure 19

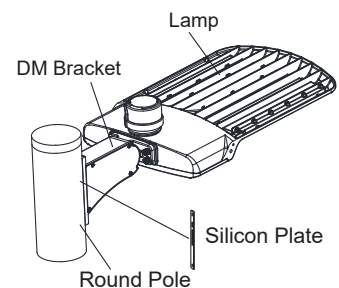

Figure 20

ZOHO™

6TH GEN

Area Light



Installation

4. YOKE MOUNTING (YM)

Step 1: Drill holes on the wall as shown. (Figure 21)

Step 2: Knock the expansion bolts into the wall. (Figure 22)

Step 3: Connect the fixture to the bracket and tighten the screws; connect the wires properly and put them into junction box. (Figure 23)

Notice: Adjustable angle is 0-90°(Figure 23)

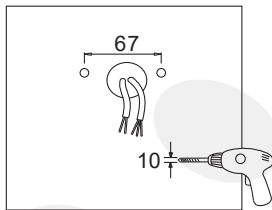

Figure 21

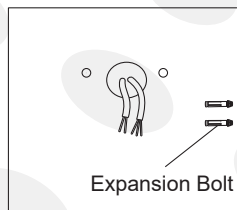

Figure 22

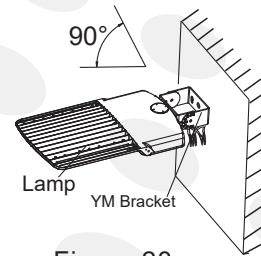

Figure 23

5. FLOOD MOUNTING (FM)

Install the mount to the fixture, tighten the mount and install the screws. (Figure 24)

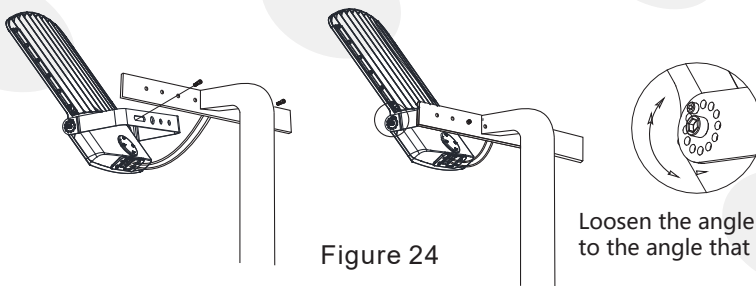

Figure 24

Loosen the angle to adjust the screw, after adjust to the angle that you need, then tighten the screws.

Instructions for Photocell

When the photocell function is required, photocell should be installed on the back of lamp; When it's not required, shorting cap should be installed on the back of lamp (Figure 25)

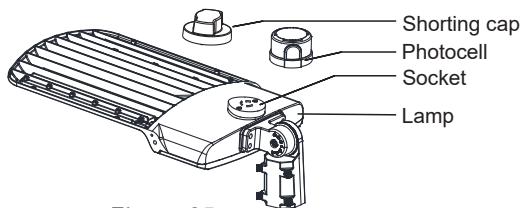

Figure 25

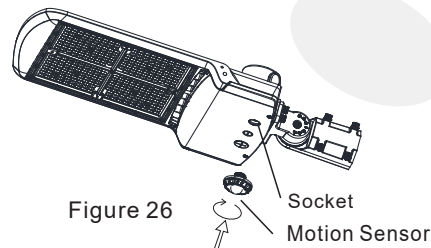

Figure 26

Standard wire:

L/live wire: Black\Brown;

N/null wire: White\Blue;

Ground wire: Green\Yellow-green.

Instructions for Motion Sensor

For products with motion sensor function, the induction module should be installed on the socket of the motion sensor. (Figure 26)



ZOHO

6TH GEN

Area Light

Installation

Instructions for Motion sensor (Figure 26)

Technical data	
Operating voltage	12±2V DC
Operating current	30mA
Output	DIM 0-10V
Stand-by power	<0.5W
Brightness	0%-100%/Quick setting:70%/80%/90%/100%
Sensitivity	20%/50%/75%/100%
Hold time	10s/1min/10min/30min
Daylight threshold	10Lux/30Lux/50Lux/100Lux/Disable
Stand-by time	1min/30min/60min/+∞
Stand-by dimming level	10%/20%/30%/50%
Microwave frequency	5.8GHz±75MHz
Microwave power	<0.5mW
Detection angle	150° (wall mounted) 360° (ceiling mounted)
Control line	Pink:+12V; Purple:DIM+; Gray:GND/DIM-
Mounting height	Max.15m(ceiling mounted)
Detection range	Max.ø15m(ceiling mounted) Max.20m(wall mounted)
Operating temperature	-30°C~+60°C
IP rating	IP65

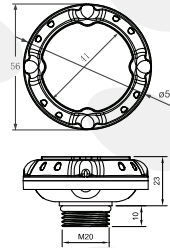
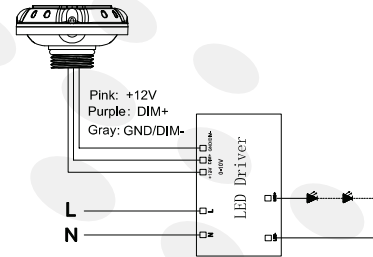

CCT Adjustment

1. Unscrew the 3/4 plug, as shown in the figure 27.
2. Adjust the switch to get the desired color temperature according to the content on the label.
3. Install and tighten the 3/4 plug.

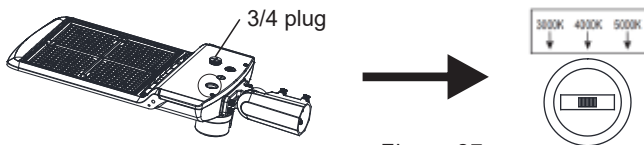

Figure 27

CCT Adjustment and Wattage adjustment Instruction

1. Unscrew the 3/4 plug, as shown in the figure 28;
2. Adjust the wattage switch or CCT switch to get the desired wattage or color temperature according to the label on the fixture
3. Install and tighten the 3/4 plug.

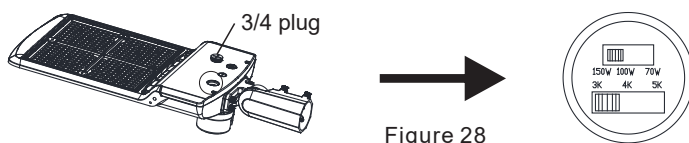

Figure 28

ZOHO™

6TH GEN

Area Light



Installation

Instructions for PIR sensor (Figure 26)

Technical data	
Operating voltage	12±2V DC
Operating current	30mA
Output	DIM 0-10V
Stand-by power	<0.5W
Brightness	0%-100%/Quick setting:70%/80%/90%/100%
Sensitivity	20%/50%/75%/100%
Hold time	10s/1min/10min/30min
Daylight threshold	10Lux/30Lux/50Lux/100Lux/Disable
Stand-by time	1min/30min/60min/+∞
Stand-by dimming level	10%/20%/30%/50%
Detection angle	30-120°
Control line	Pink:+12V; Purple:DIM+; Gray:GND/DIM-
Mounting height	Max.6m(ceiling mounted)
Detection range	Max.∅ 8m(ceiling mounted) Max.6m(wall mounted)
Operating temperature	-30°C~+60°C
IP rating	IP65

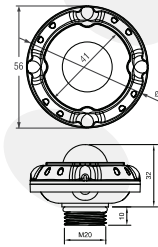
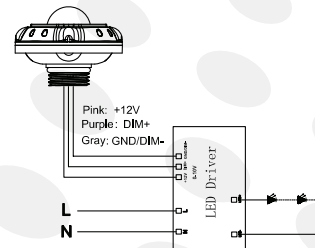

Note:

Default setting: Brightness: 100% Hold time: 1min, Stand-by dimming level: 20%, Stand-by time: 1min, Sensitivity: 100%, Daylight: Disable.

⚠ WARNING

NOTE: Warm up time is 15seconds. After the sensor connects input power first time, the light will keep on 15seconds, then go to dimming to work normally.

NOTE: Factory Default Setting: 100% sensitivity, Hold on time: 10seconds, Daylight sensor is 30lux, Dimming level: 30%, Dimming time: 60minutes.

NOTE: Any setting changed by DIP Switch or remote control, the led light that sensor connect will on/off as confirm.

THIS PRODUCT MUST BE INSTALLED IN ACCORDANCE WITH THE APPLICABLE INSTALLATION CODE BY A PERSON FAMILIAR WITH THE CONSTRUCTION AND OPERATION OF THE PRODUCT AND THE HAZARDS INVOLVED. CAUTION - RISK OF FIRE. CONSULT A QUALIFIED ELECTRICIAN TO ENSURE CORRECT BRANCH CIRCUIT CONDUCTOR MIN 75°C SUPPLY CONDUCTORS



ZOHO

6TH GEN
Area Light

Notice For User

- Please turn off power before install or change assembly parts.
- The input voltage and lamps should be matched, after connecting the power line, Please make sure the wiring section is insulated.
- No-professionals, must not install and disassemble the lamps.

TROUBLE SHOOTINGS

Troubles	Check Points
Flickering of the light	Turn off the power and turn on again in 3 minutes. If same phenomena occur, then call agencies.
Out of working	Please check the connection.

Packaging

SKU#	Box Dimension	Qty	Net Weight	Gross Weight
156834	29.13" x 14.96" x 5.63"	1 PC/Box	11.90 LBS	14.99 LBS
156752-1	25.60" x 12.20" x 5.83"	1 PC/Box	9.03 LBS	11.46 LBS
157263	25.60" x 12.20" x 5.83"	1 PC/Box	9.03 LBS	11.46 LBS
156838-1	25.60" x 12.20" x 5.83"	1 PC/Box	9.03 LBS	11.46 LBS
156796-1	29.13" x 14.96" x 5.63"	1 PC/Box	11.90 LBS	14.99 LBS
156800-1	29.13" x 14.96" x 5.63"	1 PC/Box	11.90 LBS	14.99 LBS
157218	29.13" x 14.96" x 5.63"	1 PC/Box	11.90 LBS	14.99 LBS

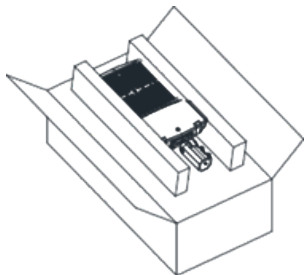

ZOHO™

6TH GEN
Area Light



Application Image



AREA LIGHT

Warranty

This product is covered under a 5-year warranty. For complete warranty details, [Click Here.](#)