

# FBN-1330LEDFH-MW - Fabiana 30W 3CCT Flush Mount, MW

30W Flush Mount, Matte White 3 Colour Change Temperature

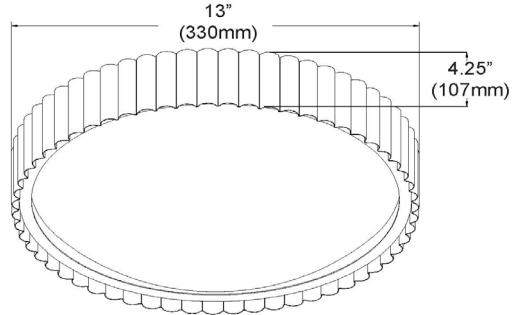

<b>Height</b>	4.25"
<b>Width/Length</b>	13"
<b>Depth</b>	13"
<b>Weight</b>	3 lbs

<b>Body Material</b>	Metal
<b>Finish/Color</b>	Matte White
<b>Type of Finish</b>	Painted

<b>Light Qty</b>	1
<b>Light Base</b>	AC LED
<b>Light Max Watt</b>	30
<b>Light Inc</b>	Yes
<b>Light Lumens</b>	1500-1600(Initial) 800-850(Delivered)
<b>Light CRI</b>	90+
<b>Light CCT</b>	2700K/3000K/4000K
<b>Light Life</b>	30000 Hours

<b>Dimmable</b>	Dimmable
<b>LED Compatible</b>	Integrated LED
<b>Total Wattage</b>	30W

<b>Second Material</b>	Glass
<b>Second Finish/Color</b>	White

<b>Rated For</b>	Damp Location
<b>Voltage</b>	120V

<b>Approval</b>	cUL or equivalent
<b>Warranty</b>	3 Years Limited
<b>Install Position</b>	Ceiling

Date:	Notes:
Fixture Type:	
Job Name:	

Lighting | LED | Shades | Custom Designs

[www.dainolite.com](http://www.dainolite.com) | 1-888-564-1262 | [dainolite@dainolite.com](mailto:dainolite@dainolite.com)

