

EUROfase

Artell, Mirror , 32" X 32", Brushed Silver

Item No.
48976-022

JOB NAME:

DATE:

TYPE:

COMMENTS:

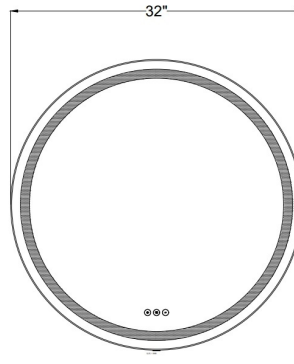

FRONT VIEW

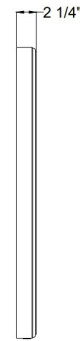

RIGHT SIDE

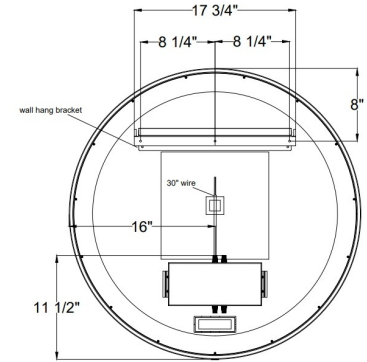

REAR VIEW

PRODUCT FEATURES

Feature 1: High quality, lead free, copper free corrosion resistant glass.

Feature 2: Durable, damp-rated construction for the frame, parts, and hardware.

Feature 3: Meets Title 24 requirements.

Feature 4: Safety added Shatter proof adhesive backing mirror panes.

Feature 5: High-efficiency LED chips produce maximum lumens while using minimal power.

Feature 6: 90+ Color Rendering Index.

Feature 7: Convenient and safe wall mounting bracket design.

Feature 8: The memory function allows the mirror to return to its last used setting when it is turned on or off from the wall switch.

DIMENSIONS & WEIGHT

Product Width (In)	
Product Height (In)	
Product Ext (In)	2.13
Product Diameter (In)	32
Product Weight (Lbs)	23.58

LIGHT INFORMATION

Light Direction	Ambient
Dimming Method	Touch Switch
Input Voltage	120
CRI	90
Delivered Lumens	968
Colour Temperature (Kelvin)	3000K/4500K/6400K
Average Hours LED (L70)	52000

PRODUCT FINISH

Finish: Brushed Silver

INSTALLATION

Mounting Type	J-Box
Mounting Location Rating	Damp