

## Single lamp monopoint

# 88291

## INSTALLATION SHEET

- 1.** Remove the fixture from its original packaging. Remove the canopy mounting plate from within the canopy and attach it to the electrical junction box using the two screws provided in the hardware package.
- 2.** Now attach the canopy to the mounting plate which, is attached to the electrical junction box. First attach all wiring with the provided marrets (white to white "N", black to black "L", ground to ground "G"). Push the canopy onto the mounting plate and align the hole on each side of the canopy to the holes on the mounting plate. Once aligned, screw in the two screws provided to secure the fixture to the mounting plate.
- 3.** You can now install the GU-10 light bulb of the correct wattage.
- 4.** Install the glass lamp cover onto the fixture by gently placing the cover on to the lamp socket head. Carefully screw the cover on to the fixture head in a clockwise motion until the glass lamp cover is firmly in place (do not over tighten).
- 5.** You have now completed the installation of your fixture, please enjoy.

### START FROM HERE

- Make sure power is completely off at the fuse box.
- Have your fixture installed by a qualified licensed electrician
- Prepare everything in clear area.
- Wear gloves at all times during this installation.
- Read instructions carefully before you start assembly.
- Keep this instruction sheet for future reference.

**Technical Support:** 1-877-452-6858

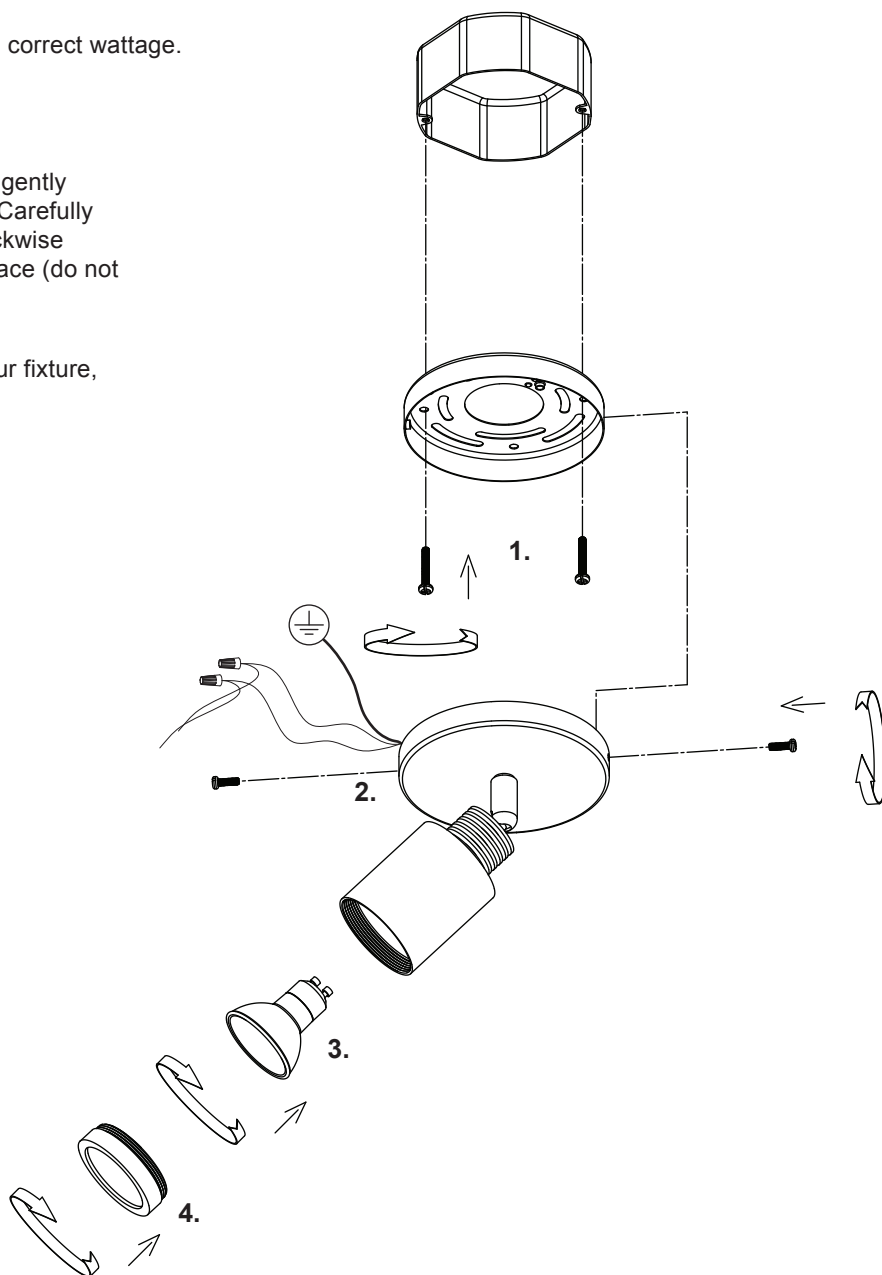

# KUZCO LIGHTING

19054 28th Avenue Surrey, BC Canada V3S 6M3  
T: 604 538 7162 TF: 1-855 85 KUZCO F: 604 538 7196  
W: kuzcolighting.com