

LED Chandelier

CH96644
INSTALLATION SHEET

START FROM HERE

- Make sure power is completely off at the fuse box.
- Have your fixture installed by a qualified licensed electrician
- Prepare everything in a clear area.
- Wear gloves at all times during this installation.
- Read instructions carefully before you start assembly.
- Keep this instruction sheet for future reference.

Technical Support: 1-877-452-6858

Please Note:

- For dimming, an ELV (Electronic Low Voltage) or a TRIAC type of dimmer is required.

- 1.** Remove the fixture from its original packaging. Next, remove the crossbar (1c) within the canopy (2a) by removing the screws (2b). Secure the crossbar (1c) to the electrical junction box (1a) with screws (1d). Connect all wires (1b) around the crossbar (1c) correctly black to black "L", white to white "N" and the ground wire with provided marrettes from the hardware package. Secure the mounting crossbar (1c) to the junction box (1a) with screws (1d) provided in the hardware package. Make sure to reinforce the wood behind the drywall for extra support and use the woodscrews (1e) to secure the crossbar (1c) to the ceiling.
- 2.** Before you mount the canopy to the mounting crossbar, select the desired length you would like the fixture to hang down from the ceiling. To set the fixture hanging height, simply push in the sleeve at the canopy where the wire comes out from. Push the wire up to shorten, or pull the wire down to lengthen. Release the sleeve and the wire will be held tightly in place.
- 3.** You are now ready to mount the canopy to the crossbar. Align the holes on the sides of canopy (2a) with the holes on the sides of crossbar (1c). Next, push the canopy (2a) to the mounting crossbar (1c) and use the screws (2b). This will secure the canopy to the mounting crossbar.
- 4.** You have now completed the installation of your fixture, enjoy.

Note: Avoid to expand the fixture height in vertical extension max 8"(20cm).

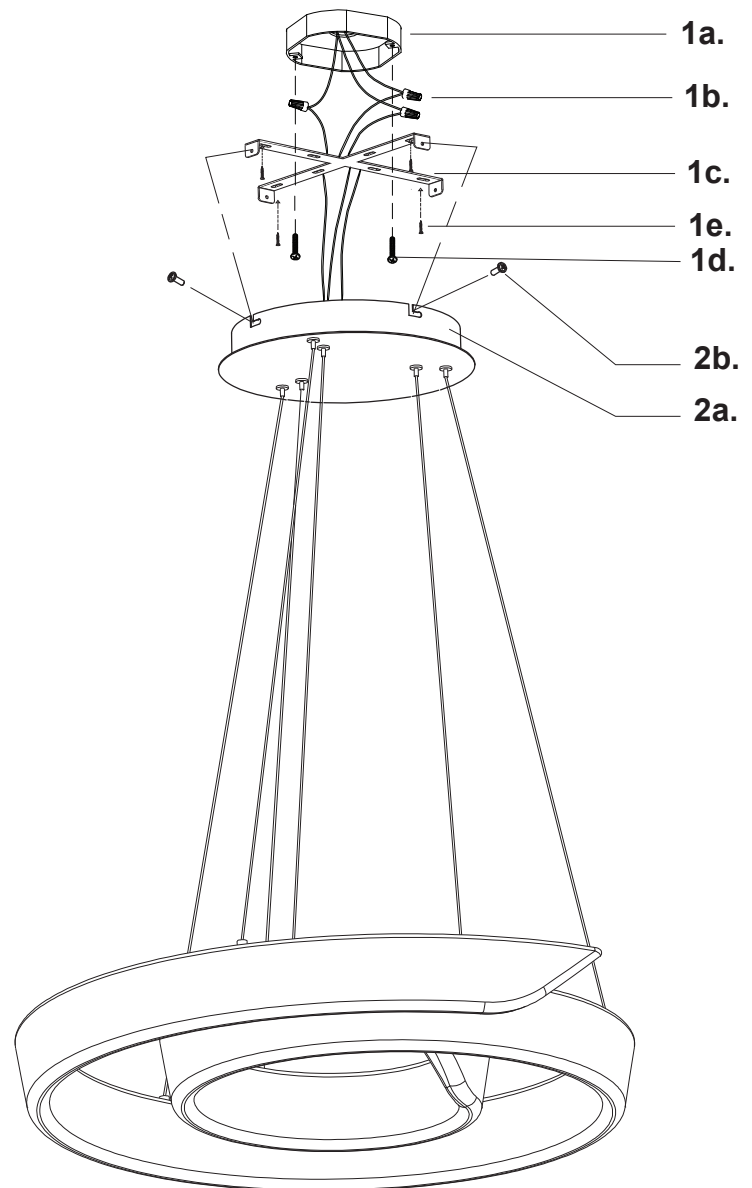

KUZCO

19054 28th Avenue Surrey, BC Canada V3S 6M3
T: 604 538 7162 TF: 1-855 85 KUZCO F: 604 538 7196
W: kuzcolighting.com
20160509