

ARC60P042

ArcArrest® Switch-Rated Pin & Sleeve Plug



60 Amp, 480 Volt, 2P+G, ArcArrest Switch-Rated Pin & Sleeve Plug without Drawplate, NEMA Type 4X, IP69K Rated, UL2682 - Gray

ArcArrest Switch-Rated Pin & Sleeve devices provide a safe, efficient way to de-energize industrial equipment – providing a local means of disconnect as required by NEC and OSHA. These devices are also rated as both branch circuit disconnect switches and motor circuit disconnect switches, ensuring compliance for a wide range of industrial applications.

Color :  Gray

UPC Code : 078477031995

Country Of Origin : Mexico

- No exposure to live electrical components or arc flash, even when operating under load
- Lockout tagout provisions in both plug and receptacle allow for fast compliance with OSHA
- Integrates both a wall-mounted disconnect and plug and connector, providing you more flexibility and portable applications
- Eliminates ingress of dust, water, and high-temperature, high-pressure washdowns with Type 4X and IP69K ratings
- Maintains a watertight seal whether connected or disconnected - when unmated, devices remain protected with receptacle lid or plug cap

Technical Information

Electrical Specifications

Pole : 2P+G

Voltage : 480V

Amperage : 60A

Wire : 3

Environmental Specifications

Corrosion Resistance :

Ferrous parts immersed in 20° C, 10 percent ammonium chloride solution for 10 min

Flammability : Rated V-0 per UL 94

IP Rating : IP67/IP69K

NEMA Enclosure Type : 4X

Operating Temperature : -20° C to 60° C

UV Resistance : Exposed plastic materials are UV stabilized

Material Specifications

Assembly Screws : Stainless Steel

Body Material : PC/PBT

Contact Carrier : PC/PBT

Contacts : Unplated or Silver-Plated Copper Alloy

Mechanical Specifications

Cold Impact : Drop from 30" 8 times after conditioning to -25° C, for 6 hours

Cord Grip Range (in) : 0.750-1.125

Hardware Head Type : Hex Style socket screw for

Gasket Material : EPDM or Silicone
Gland Cap : PC/PBT
Grommet/Gasket : NBR/PVC
Housing : PC/PBT
Phase and Ground Pins : Copper Alloy
Phase and Ground Sleeves : Nickel Plated Brass
Terminal Screws : Stainless Steel
Washer : HDPE

terminals, philips head for all others
Terminal Accom. : #8AWG - #4AWG

Product Features

Color : Gray
Lockout/Tagout Provision : Lockout hole on housing
Plug : Device Type
Product Markings : Brand, UL and environmental ratings molded in. Item number, ampacity, voltage, phases, HP on label
Series : ArcArrest

Standards and Certifications

CSA : CSA 22.2 182.1-17 (Harmonized with UL1682)
RoHS : RoHS compliant components
UL : UL1682|UL2682

Warranty

Warranty : 1-Year Limited

Dimensional Drawing

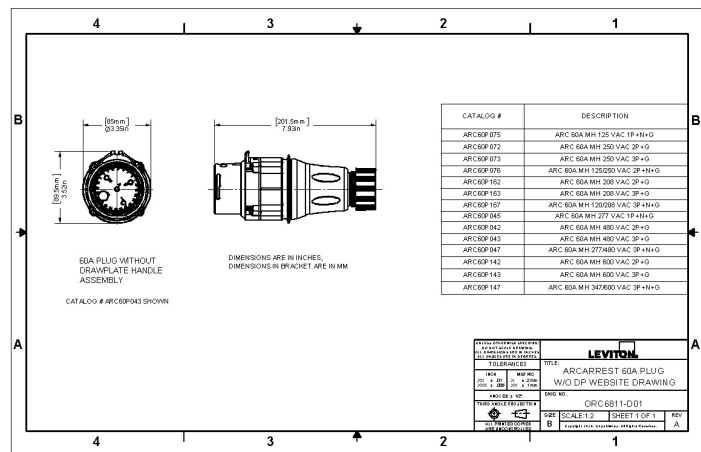

SPECIFICATION SUBMITTAL

<p>JOB NAME:</p> <input style="width: 90%; height: 20px;" type="text"/> <p>JOB NUMBER:</p> <input style="width: 90%; height: 20px;" type="text"/>	<p>CATALOG NUMBERS:</p> <table border="1" style="width: 100%; height: 40px;"> <tr> <td style="width: 50%;"></td> <td style="width: 50%;"></td> </tr> </table> <table border="1" style="width: 100%; height: 40px;"> <tr> <td style="width: 50%;"></td> <td style="width: 50%;"></td> </tr> </table>				

201 North Service Road, Melville, NY 11747

Telephone: +1-800-323-8920 · FAX: +1-800-832-9538 · Tech Line (8:30AM-7:30PM E.S.
T. Monday-Friday): +1-800-824-3005

Leviton Manufacturing of Canada, Ltd.

165 Hymus Boulevard, Pointe Claire, Quebec H9R 1E9 · Telephone: +1-800-461-2002 ·
FAX: +1-800-824-3005 ·

Leviton S. de R.L. de C.V.

Lago Tana 43, Mexico DF, Mexico CP 11290 · Tel.: (+52)55-5082-1040 · FAX: (+52)
5386- 1797 ·

Visit our Website at: www.leviton.com

© 2026 Leviton Manufacturing Co., Inc. All Rights Reserved. Subject to change without
notice.

Leviton has a global presence.

If you would like to know where your local Leviton office is located please go to:
www.leviton.com/company/about-leviton/locations

© 2026 Leviton Manufacturing Co., Inc.