

# LEDBARKIT-INTERNAL DRIVER (LBI) THE LINEAR TRANSFORMER



 120-277V (Standard) or 240-347V (High Voltage) <b>VOLTAGE</b> <small>(240-347V FOR CANADA ONLY)</small>	 <b>0-10V DIM</b> <b>DIM to OFF</b> <b>12V AUX</b> <b>SENSOR READY</b>	 <b>UP TO</b> <b>146</b> <b>LPW</b> <b>EFFICACY</b> <small>(LIGHT ENGINE)</small>	 <b>-25°C TO 60°C</b> <b>OPERATING TEMP</b>	 <b>&lt;20%</b> <b>THD</b> <b>&gt;0.9</b> <b>PWR FACTOR/THD</b>	 <b>80+</b> <b>CRI</b>	 <b>EMG</b> <b>OPTIONAL EMG</b> <b>BATTERY BACKUP</b>	 <b>OPTIONAL</b> <b>MOTION SENSOR</b>
---	--	--	---	---	------------------------------	--	---

## one light – unlimited possibilities



available in both  
**BASE & PRO**

	<b>PRO</b>	<b>BASE</b>
DIMMABLE	✓ 0-10V	—
CONTROL POWER	✓ 12V	—
FLEX COLOR	✓	—
FLEX WATT	✓	—
WARRANTY	10YR	5YR
L70	>100,000 HRS	50,000 HRS

### DEFAULT CONFIGURATIONS

PART #	UPC	DESCRIPTION	WATTAGE	LUMENS	LPW	CCT (K)	DLC PRODUCT CODE
RP-LBI-G1-2F-6W-27K-WC2	844006024826	2FT PRO WARM CCT INTERNAL DRIVE LIGHT BAR	6/9/12	696-1524	116-127	2700/3000/3500	
RP-LBI-G1-2F-6W-40K-WC	844006023867	2FT PRO INTERNAL DRIVE LIGHT BAR	6/9/12	780-1560	126-137	3500/4000/5000	PFLO5RPC
RP-LBI-G1-3F-10W-27K-WC2	844006024833	3FT PRO WARM CCT INTERNAL DRIVE LIGHT BAR	10/12/15	1270-1980	127-132	2700/3000/3500	
RP-LBI-G1-3F-10W-40K-WC	844006023959	3FT PRO INTERNAL DRIVE LIGHT BAR	10/12/15	1400-2100	137-142	3500/4000/5000	PTTC4A0W
RP-LBI-G1-4F-15W-27K-WC2	844006024840	4FT PRO WARM CCT INTERNAL DRIVE LIGHT BAR	10/15/25	1260-3400	126-136	2700/3000/3500	
RP-LBI-G1-4F-15W-40K-WC	844006024079	4FT PRO INTERNAL DRIVE LIGHT BAR	10/15/25	1462-3653	136-146	3500/4000/5000	PCW0MQPB
RP-LBI-G1-4F-15W-40K-B	844006024215	4FT BASE INTERNAL DRIVE LIGHT BAR	15	1996	139	4000	PMROEESV

Default settings are above. See pages 7 and 8 for additional styles, lumen packages, color temperatures and options.

### POPULAR ACCESSORIES (SOLD SEPARATELY)

 <b>EMERGENCY BATTERY BACKUP</b>	 <b>LINKING CABLES</b>	 <b>SEAMLESS CONNECTOR</b>	 <b>OC2 SENSOR KIT</b>	 <b>SUSPENDED IN-LINE BRACKET KIT</b>	 <b>INCOMING POWER KIT*</b>
-------------------------------------	---------------------------	-------------------------------	---------------------------	--	--------------------------------

**\*INCOMING POWER KIT NOW SOLD SEPARATELY – SEE PAGE 3 FOR DETAILS**

(SEE PAGE 11 FOR MORE ACCESSORIES)



LIGHT EFFICIENT DESIGN HEADQUARTERS 188 S. Northwest Highway • Cary, IL 60013  
INNOVATION & MANUFACTURING CENTER 30 Log Bridge Road, Building 200 • Middleton, MA 01949  
847.380.3540 • led-llc.com

# LED BARKIT-INTERNAL DRIVER (LBI) THE LINEAR TRANSFORMER



## Usage & Applications

One solution. ETL and DLC listed as both a retrofit kit and a fixture.



Using the fast install magnetic brackets, light bars fit between any T5, T8 or T12 socketed fixture including

### TROFFERS



Example 2x2 and 2x4 retrofitted with 3 light bars.



COVE LIGHTING

### RETROFIT MOUNTING KITS

Mount light bar to a Retrofit Mounting Kit for a faster, cleaner install.  
- contact us for details.

ETL and DLC listed as a fixture under the following categories

### STAIRWELL FIXTURE

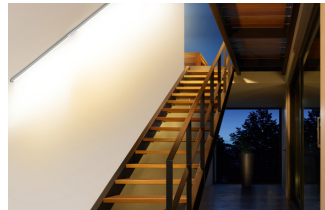

### LINEAR AMBIENT FIXTURE

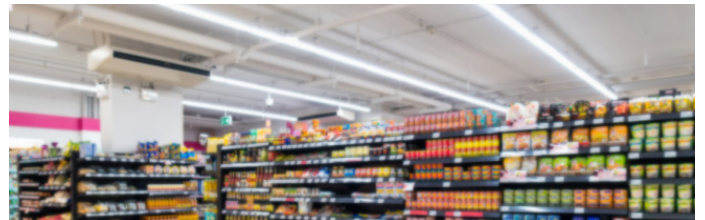

HIGH BAY FIXTURE (LOW CEILING HEIGHTS)

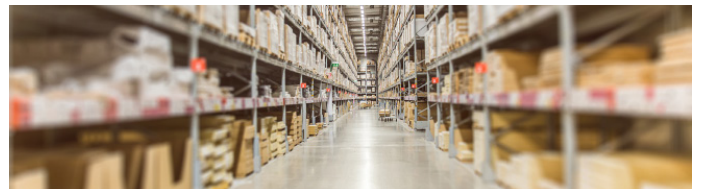

HIGH BAY FIXTURE (HIGH CEILING HEIGHTS)

### FIXTURE HOUSING KITS

Mount light bar to a Fixture Housing Kit for a faster, cleaner install.  
- contact us for details.



# LED BARKIT-INTERNAL DRIVER (LBI) THE LINEAR TRANSFORMER



INCLUDED WITH EVERY BAR

**2X** Surface Mount Magnetic Clips  
(w/ easy bend and break lines)

**4X** 1/4" hex head-self drilling screws

**1X** Flex setting cover



INCOMING POWER KIT: RP-LBI-G1-IP-3F-DIM – SOLD SEPARATELY

**1A** Incoming power cable (bar input side)

**1B** Incoming power cable (pigtail side)

**1X** Service Disconnect

**1X** Abrasion protection grommet

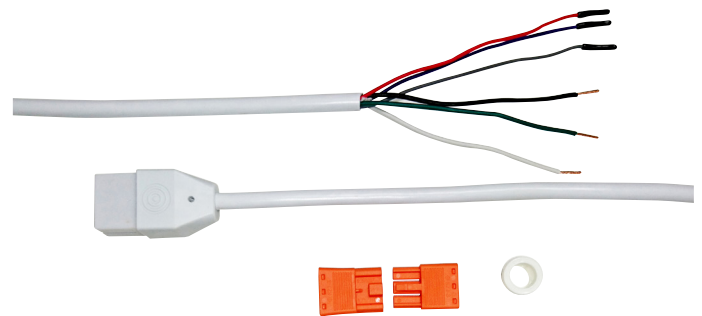

WIRING DIAGRAM

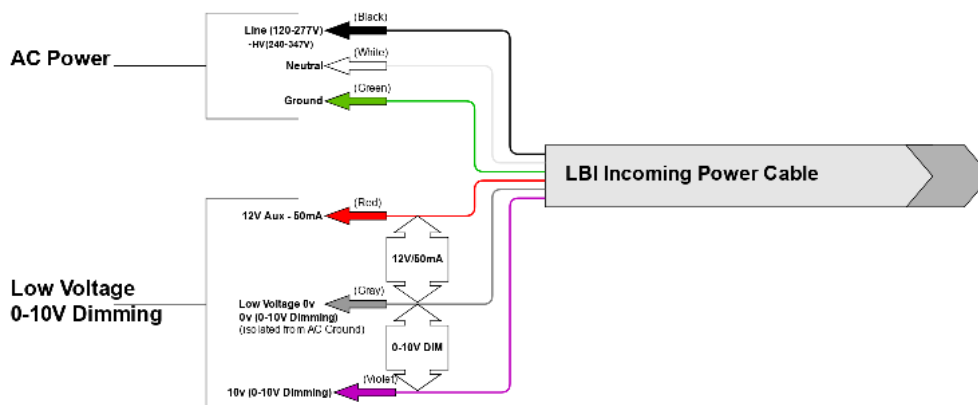

LIGHT EFFICIENT DESIGN HEADQUARTERS 188 S. Northwest Highway • Cary, IL 60013  
 INNOVATION & MANUFACTURING CENTER 30 Log Bridge Road, Building 200 • Middleton, MA 01949  
 847.380.3540 • led-llc.com

# —○ LEDBarKit-Internal Driver (LBI) Design Guide

A comprehensive guide to understanding, specifying, stocking, and selling the LEDBarKit-Internal Driver fluorescent replacement.



## The Linear Transformer

With up to 146 lumens per watt, and up to 25 years of virtually maintenance free operation, learn why smart decision makers use the The Linear Transformer when upgrading to LED.

### —○ Perfect replacement for

- Linear and general purpose
- Strips & Wraps
- Troffers
- Vapor Tights
- Low bay and High bay
- Coves and Soffits
- Stairwells



LIGHT EFFICIENT DESIGN HEADQUARTERS 188 S. Northwest Highway • Cary, IL 60013  
INNOVATION & MANUFACTURING CENTER 30 Log Bridge Road, Building 200 • Middleton, MA 01949  
847.380.3540 • led-llc.com

# —○ LEDBarKit-Internal Driver (LBI)

## FEATURES

The Linear Transformer is available in both BASE and PRO versions – choose which is best for you!



9 SKUs in 1 WITH FLEXWATT™  
& FLEXCOLOR™ TECHNOLOGY

flex:WATT	2FT	6W	9W	12W
	3FT	10W	12W	15W
	4FT	10W	15W	25W

- Eliminate ordering and stocking multiple wattages and color temperatures. Product offers 9 SKUs in 1 unit which can easily be configured to 3 different wattage packages and 3 different CCTs.

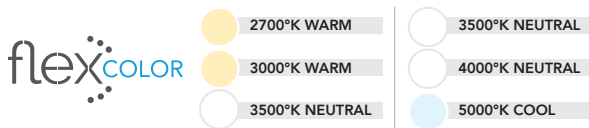

- Product ships at a default color temp (K) and wattage setting (install as is, or tailor the settings to fit your needs).
- Save on labor costs by having us factory pre-set the wattage and color temperature.

### FLEXCONTROL™ TECHNOLOGY

- Order control ready or basic control (integrated high/low and daylight sensor) or advanced controls (such as, Philips Easy Sense, Avi-On Bluetooth or Lutron Vive).
- Optional sensors are directly linkable to the light bars.
- Our basic motion/daylight control (OC2 ordering code) is adjustable via remote control for (1) sensitivity (2) duration of time at high light level before dimming to low (2) duration of time at low light level before turning off (3) ramping up and down light levels based on daylight and (4) the dimmed light level %.

### SUITABLE FOR DRY & DAMP LOCATIONS

#### PASS-THROUGH 0-10V DIMMING & AUXILIARY 12V OUTPUT

- Allows all light bars to be dimmed together as a group.

#### ADAPTABLE MOUNTING

- Various mounting clip options with integrated rare-earth magnets for easy placement in all style fixtures.
- High Bay pendant chain options available.

#### CONNECT UP TO 40 LIGHT BARS ON ONE INCOMING POWER CABLE

Up to 146 LUMENS PER WATT EFFICACY

10 YEAR WARRANTY, L70 >100,000HRS

OPTIONAL EMERGENCY BATTERY BACKUP

OPTIONAL BAA SECTION 1605

### SUITABLE FOR DRY & DAMP LOCATIONS

#### ADAPTABLE MOUNTING

- Various mounting clip options with integrated rare-earth magnets for easy placement in all style fixtures.
- High Bay pendant chain options for high bay installation.

#### CONNECT UP TO 40 LIGHT BARS ON ONE INCOMING POWER CABLE

139 LUMENS PER WATT EFFICACY

5 YEAR WARRANTY, L70 >50,000HRS

OPTIONAL EMERGENCY BATTERY BACKUP

OPTIONAL BAA SECTION 1605



# LEDBarKit-Internal Driver (LBI)

## FLEXWATT + FLEXCOLOR

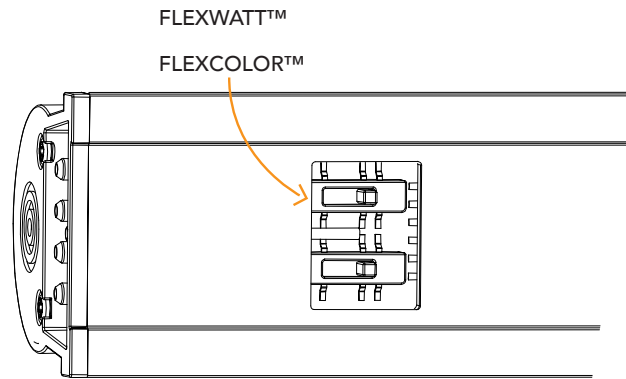

2FT	6W	9W	12W
3FT	10W	12W	15W
4FT	10W	15W	25W

### HOW IT WORKS

Our exclusive LED driver is designed to operate at 90%+ efficiency at each wattage setting. Our competitor's drivers have much lower efficiency (as low as 60%) which results in poor performance and reduced efficacy.

### WATTAGE CHOICES

<b>2FT</b>	<b>6W</b>	<b>9W</b>	<b>12W</b>
<b>3FT</b>	<b>10W</b>	<b>12W</b>	<b>15W</b>
<b>4FT</b>	<b>10W</b>	<b>15W</b>	<b>25W</b>

### WATTAGE SELECTION

Adjust the 3-position slide switch, no tools required.



- 2700°K WARM
- 3000°K WARM
- 3500°K NEUTRAL

---

- 3500°K NEUTRAL
- 4000°K NEUTRAL
- 5000°K COOL

### HOW IT WORKS

We select the highest efficacy, multiple color LED diodes from quality suppliers, and mount them on the circuit board. A proprietary LED binning process ensures color consistency between fixtures. The FlexColor technology ensures the desired color is selected, every time.

### COLOR CHOICES

	FLEXCOLOR SLIDE SWITCH POSITION		
	TOP	MIDDLE	BOTTOM
... -27K-WC2	2700K	3000K	3500K
... -40K-WC	3500K	4000K	5000K

### COLOR SELECTION

Adjust the 3-position slide switch, no tools required.



LIGHT EFFICIENT DESIGN HEADQUARTERS 188 S. Northwest Highway • Cary, IL 60013  
 INNOVATION & MANUFACTURING CENTER 30 Log Bridge Road, Building 200 • Middleton, MA 01949  
 847.380.3540 • led-llc.com

# LEDBarKit-Internal Driver (LBI)

## EXPLODED CONSTRUCTION VIEW

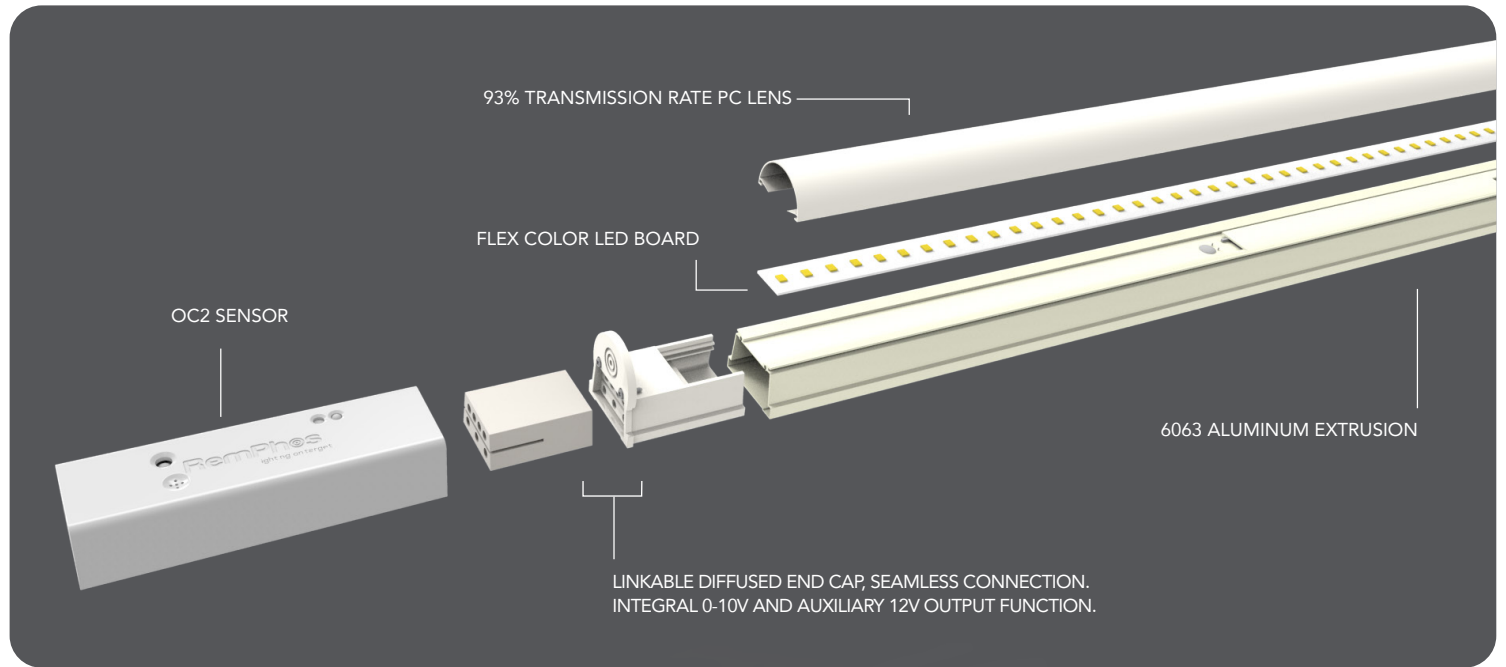

### INCLUDED WITH EVERY BAR

2X Surface Mount Magnetic Clips  
(w/ easy bend and break lines)

4X 1/4" hex head-self drilling screws



### DIMENSIONS

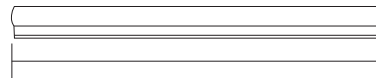

19.3"

RP-LBI-G1-2F-...

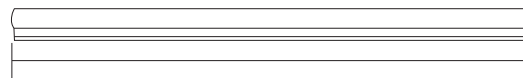

31.3"

RP-LBI-G1-3F-...

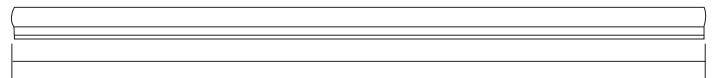

43.3"

RP-LBI-G1-4F-...

#### Cable Dimensions

7.25mm - 0.28 Inch for DIM cable.

6.35mm - .25 inch for NO-DIM cables

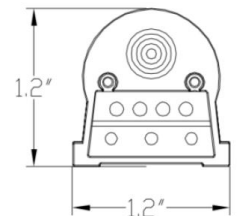
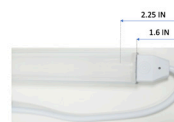
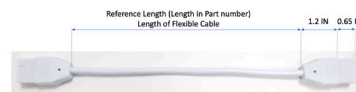

LIGHT EFFICIENT DESIGN HEADQUARTERS 188 S. Northwest Highway • Cary, IL 60013  
 INNOVATION & MANUFACTURING CENTER 30 Log Bridge Road, Building 200 • Middleton, MA 01949  
 847.380.3540 • led-llc.com

# LEDBarKit-Internal Driver (LBI)

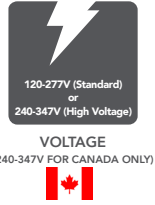

PART #	# of Bars	CCT Selections	Wattage Per Bar	Lumens Per Bar	Total Wattage	Total Lumens	DLC/QPL (FIXTURE)		DLC/QPL (RETROFIT)	
							Linear Ambient	High-Bay	Linear Ambient	Troffers
RP-LBI-G1-2F-6W-POXK-WC2-[BAA]	1	27K/30K/35K	6	700	6	700	PO6968KO			S
RP-LBI-G1-2F-6W-POXK-WC2-HV-[BAA]	1	27K/30K/35K	6	700	6	700	PRWUJ698			S
RP-LBI-G1-2F-6W-POXK-WC-[BAA]	1	35K/40K/50K	6	770	6	770	PFL05RPC			P
RP-LBI-G1-2F-6W-POXK-WC-HV-[BAA]	1	35K/40K/50K	6	770	6	770	PGHKU11Q			P
RP-LBI-G1-2F-9W-POXK-WC2-[BAA]	1	27K/30K/35K	9	1120	9	1120	PRZ7TY99			S
RP-LBI-G1-2F-9W-POXK-WC2-HV-[BAA]	1	27K/30K/35K	9	1120	9	1120	P22HG6PP			S
RP-LBI-G1-2F-9W-POXK-WC-[BAA]	1	35K/40K/50K	9	1285	9	1285	P56G7BMO			P
RP-LBI-G1-2F-9W-POXK-WC-HV-[BAA]	1	35K/40K/50K	9	1285	9	1285	PUQX9WLZ			P
RP-LBI-G1-2F-12W-POXK-WC2-[BAA]	1	27K/30K/35K	12	1480	12	1480	PTH2NCJ			S
RP-LBI-G1-2F-12W-POXK-WC2-HV-[BAA]	1	27K/30K/35K	12	1480	12	1480	P1G3Q32M			S
RP-LBI-G1-2F-12W-POXK-WC-[BAA]	1	35K/40K/50K	12	1600	12	1600	PSZAPJNF			P
RP-LBI-G1-2F-12W-POXK-WC-HV-[BAA]	1	35K/40K/50K	12	1600	12	1600	P9BNSJTA			P
RP-LBI-G1-3F-10W-POXK-WC2-[BAA]	1	27K/30K/35K	10	1268	10	1268	PO9EOKA7			S
RP-LBI-G1-3F-10W-POXK-WC2-HV-[BAA]	1	27K/30K/35K	10	1268	10	1268	PCKK6TR1			S
RP-LBI-G1-3F-10W-POXK-WC-[BAA]	1	35K/40K/50K	10	1434	10	1434	PTTC4A0W			P
RP-LBI-G1-3F-10W-POXK-WC-HV-[BAA]	1	35K/40K/50K	10	1434	10	1434	PHF5Y0NJ			P
RP-LBI-G1-3F-12W-POXK-WC2-[BAA]	1	27K/30K/35K	12	1522	12	1522	PN2DTHBC			S
RP-LBI-G1-3F-12W-POXK-WC2-HV-[BAA]	1	27K/30K/35K	12	1522	12	1522	P1565K7			S
RP-LBI-G1-3F-12W-POXK-WC-[BAA]	1	35K/40K/50K	12	1761	12	1761	PO7LDR7			P
RP-LBI-G1-3F-12W-POXK-WC-HV-[BAA]	1	35K/40K/50K	12	1761	12	1761	PLUPBLEO			P
RP-LBI-G1-3F-15W-POXK-WC2-[BAA]	1	27K/30K/35K	15	1855	15	1855	PNLFMSKR			S
RP-LBI-G1-3F-15W-POXK-WC2-HV-[BAA]	1	27K/30K/35K	15	1855	15	1855	P217F6LD			S
RP-LBI-G1-3F-15W-POXK-WC-[BAA]	1	35K/40K/50K	15	2000	15	2000	PDF0B6O2			P
RP-LBI-G1-3F-15W-POXK-WC-HV-[BAA]	1	35K/40K/50K	15	2000	15	2000	PDWN1BQCN			P
RP-LBI-G1-4F-10W-POXK-WC2-[BAA]	1	27K/30K/35K	10	1265	10	1265	P44Q5KF3			S
RP-LBI-G1-4F-10W-POXK-WC2-HV-[BAA]	1	27K/30K/35K	10	1265	10	1265	PHWH7LZ			S
RP-LBI-G1-4F-10W-POXK-WC-[BAA]	1	35K/40K/50K	10	1462	10	1462	P950LG3J			P
RP-LBI-G1-4F-10W-POXK-WC-HV-[BAA]	1	35K/40K/50K	10	1462	10	1462	PWCY774Y			P
RP-LBI-G1-4F-15W-POXK-WC2-[BAA]	1	27K/30K/35K	15	1895	15	1895	P84SKJGB			S
RP-LBI-G1-4F-15W-POXK-WC2-HV-[BAA]	1	27K/30K/35K	15	1895	15	1895	PKFB5L62			S
RP-LBI-G1-4F-15W-POXK-WC-[BAA]	1	35K/40K/50K	15	2130	15	2130	PCW0MQPB			P
RP-LBI-G1-4F-15W-POXK-WC-HV-[BAA]	1	35K/40K/50K	15	2130	15	2130	PO03BOVX			P
RP-LBI-G1-4F-25W-POXK-WC2-[BAA]	1	27K/30K/35K	25	3160	25	3160	PL1A1TE9			S
RP-LBI-G1-4F-25W-POXK-WC2-HV-[BAA]	1	27K/30K/35K	25	3160	25	3160	PUPEQU7Y			S
RP-LBI-G1-4F-25W-POXK-WC-[BAA]	1	35K/40K/50K	25	3650	25	3650	PRNWH8GQ			P
RP-LBI-G1-4F-25W-POXK-WC-HV-[BAA]	1	35K/40K/50K	25	3650	25	3650	PFSN7WFD			P
RP-LBI-G1-2F-6W-POXK-WC2-[BAA]-2X	2	27K/30K/35K	6	700	12	1400				
RP-LBI-G1-2F-6W-POXK-WC2-HV-[BAA]-2X	2	27K/30K/35K	6	700	12	1400				
RP-LBI-G1-2F-6W-POXK-WC-[BAA]-2X	2	35K/40K/50K	6	770	12	1540		PWK6HRMR		P
RP-LBI-G1-2F-6W-POXK-WC-HV-[BAA]-2X	2	35K/40K/50K	6	770	12	1540				
RP-LBI-G1-2F-9W-POXK-WC2-[BAA]-2X	2	27K/30K/35K	9	1120	18	2240				
RP-LBI-G1-2F-9W-POXK-WC2-HV-[BAA]-2X	2	27K/30K/35K	9	1120	18	2240				
RP-LBI-G1-2F-9W-POXK-WC-[BAA]-2X	2	35K/40K/50K	9	1285	18	2570		P548I2GR		P
RP-LBI-G1-2F-9W-POXK-WC-HV-[BAA]-2X	2	35K/40K/50K	9	1285	18	2570				
RP-LBI-G1-2F-12W-POXK-WC2-[BAA]-2X	2	27K/30K/35K	12	1480	24	2960				
RP-LBI-G1-2F-12W-POXK-WC2-HV-[BAA]-2X	2	27K/30K/35K	12	1480	24	2960				
RP-LBI-G1-2F-12W-POXK-WC-[BAA]-2X	2	35K/40K/50K	12	1600	24	3200		PZT.D3B3		P
RP-LBI-G1-2F-12W-POXK-WC-HV-[BAA]-2X	2	35K/40K/50K	12	1600	24	3200				
RP-LBI-G1-3F-10W-POXK-WC2-[BAA]-2X	2	27K/30K/35K	10	1268	20	2536				
RP-LBI-G1-3F-10W-POXK-WC2-HV-[BAA]-2X	2	27K/30K/35K	10	1268	20	2536				
RP-LBI-G1-3F-10W-POXK-WC-[BAA]-2X	2	35K/40K/50K	10	1434	20	2868				
RP-LBI-G1-3F-10W-POXK-WC-HV-[BAA]-2X	2	35K/40K/50K	10	1434	20	2868				
RP-LBI-G1-3F-12W-POXK-WC2-[BAA]-2X	2	27K/30K/35K	12	1522	24	3044				
RP-LBI-G1-3F-12W-POXK-WC2-HV-[BAA]-2X	2	27K/30K/35K	12	1522	24	3044				
RP-LBI-G1-3F-12W-POXK-WC-[BAA]-2X	2	35K/40K/50K	12	1761	24	3522				
RP-LBI-G1-3F-12W-POXK-WC-HV-[BAA]-2X	2	35K/40K/50K	12	1761	24	3522				
RP-LBI-G1-3F-15W-POXK-WC2-[BAA]-2X	2	27K/30K/35K	15	1855	30	3710				
RP-LBI-G1-3F-15W-POXK-WC2-HV-[BAA]-2X	2	27K/30K/35K	15	1855	30	3710				
RP-LBI-G1-3F-15W-POXK-WC-[BAA]-2X	2	35K/40K/50K	15	2000	30	4000				
RP-LBI-G1-3F-15W-POXK-WC-HV-[BAA]-2X	2	35K/40K/50K	15	2000	30	4000				
RP-LBI-G1-4F-10W-POXK-WC2-[BAA]-2X	2	27K/30K/35K	10	1265	20	2530				
RP-LBI-G1-4F-10W-POXK-WC2-HV-[BAA]-2X	2	27K/30K/35K	10	1265	20	2530				
RP-LBI-G1-4F-10W-POXK-WC-[BAA]-2X	2	35K/40K/50K	10	1462	20	2924	PW55YB2M	PETOVYMS		P
RP-LBI-G1-4F-10W-POXK-WC-HV-[BAA]-2X	2	35K/40K/50K	10	1462	20	2924				
RP-LBI-G1-4F-15W-POXK-WC2-[BAA]-2X	2	27K/30K/35K	15	1895	30	3790				
RP-LBI-G1-4F-15W-POXK-WC2-HV-[BAA]-2X	2	27K/30K/35K	15	1895	30	3790				
RP-LBI-G1-4F-15W-POXK-WC-[BAA]-2X	2	35K/40K/50K	15	2130	30	4260	P08WGV0G	P3N42A27		P
RP-LBI-G1-4F-15W-POXK-WC-HV-[BAA]-2X	2	35K/40K/50K	15	2130	30	4260				
RP-LBI-G1-4F-25W-POXK-WC2-[BAA]-2X	2	27K/30K/35K	25	3160	50	6320				
RP-LBI-G1-4F-25W-POXK-WC2-HV-[BAA]-2X	2	27K/30K/35K	25	3160	50	6320				
RP-LBI-G1-4F-25W-POXK-WC-[BAA]-2X	2	35K/40K/50K	25	3650	50	7300		P5FLB42B		
RP-LBI-G1-4F-25W-POXK-WC-HV-[BAA]-2X	2	35K/40K/50K	25	3650	50	7300				



All models on the DLC QPL are premium listed.



LIGHT EFFICIENT DESIGN HEADQUARTERS 188 S. Northwest Highway • Cary, IL 60013  
 INNOVATION & MANUFACTURING CENTER 30 Log Bridge Road, Building 200 • Middleton, MA 01949  
 847.380.3540 • led-llc.com

# LEDBarKit-Internal Driver (LBI)

## PRODUCT SELECTION GUIDE (CONTINUED)

Default lumen package (wattage and CCT) are shown below in bold. There are two ways to achieve a non-default lumen package and/or CCT:  
 1. You can easily adjust in field via our FlexWatt and FlexColor internal switches. 2. Have us adjust the FlexWatt and FlexColor at the factory for an additional charge.

PART #	# of Bars	CCT Selections	Wattage Per Bar	Lumens Per Bar	Total Wattage	Total Lumens	DLC/QPL (FIXTURE)		DLC/QPL (RETROFIT)				
							Linear Ambient	High-Bay	Linear Ambient	Troffers	Standard/Premium		
PRO 2X BAR KITS	4FT	RP-LBI-G1-4F-10W-DOXK-WC2-[BAA]-2X	2	<b>27K/30K/35K</b>	10	1265	20	2530					
		RP-LBI-G1-4F-10W-DOXK-WC2-HV-[BAA]-2X	2	<b>27K/30K/35K</b>	10	1265	20	2530					
		RP-LBI-G1-4F-10W-DOXK-WC-[BAA]-2X	2	35K/ <b>40K/50K</b>	10	1462	20	2924	PYKU7NY		PW55YB2M	PET0VYMS	P
		RP-LBI-G1-4F-10W-DOXK-WC-HV-[BAA]-2X	2	35K/ <b>40K/50K</b>	10	1462	20	2924					
		RP-LBI-G1-4F-15W-DOXK-WC2-[BAA]-2X	2	<b>27K/30K/35K</b>	15	1895	30	3790					
		RP-LBI-G1-4F-15W-DOXK-WC2-HV-[BAA]-2X	2	<b>27K/30K/35K</b>	15	1895	30	3790					
		RP-LBI-G1-4F-15W-DOXK-WC-[BAA]-2X	2	35K/ <b>40K/50K</b>	15	2130	30	4260		P08WGV0G	P3N42A27		P
		RP-LBI-G1-4F-15W-DOXK-WC-HV-[BAA]-2X	2	35K/ <b>40K/50K</b>	15	2130	30	4260					
		RP-LBI-G1-4F-25W-DOXK-WC2-[BAA]-2X	2	<b>27K/30K/35K</b>	25	3160	50	6320					
		RP-LBI-G1-4F-25W-DOXK-WC2-HV-[BAA]-2X	2	<b>27K/30K/35K</b>	25	3160	50	6320					
		RP-LBI-G1-4F-25W-DOXK-WC-[BAA]-2X	2	35K/ <b>40K/50K</b>	25	3650	50	7300		P5FLB42B	P03S9DLK		P
		RP-LBI-G1-4F-25W-DOXK-WC-HV-[BAA]-2X	2	35K/ <b>40K/50K</b>	25	3650	50	7300					
PRO 3X BAR KITS	2FT	RP-LBI-G1-2F-6W-DOXK-WC2-[BAA]-3X	3	<b>27K/30K/35K</b>	6	700	18	2100					
		RP-LBI-G1-2F-6W-DOXK-WC2-HV-[BAA]-3X	3	<b>27K/30K/35K</b>	6	700	18	2100					
		RP-LBI-G1-2F-6W-DOXK-WC-[BAA]-3X	3	35K/ <b>40K/50K</b>	6	770	18	2310					
		RP-LBI-G1-2F-6W-DOXK-WC-HV-[BAA]-3X	3	35K/ <b>40K/50K</b>	6	770	18	2310					
		RP-LBI-G1-2F-9W-DOXK-WC2-[BAA]-3X	3	<b>27K/30K/35K</b>	9	1120	27	3360					
		RP-LBI-G1-2F-9W-DOXK-WC2-HV-[BAA]-3X	3	<b>27K/30K/35K</b>	9	1120	27	3360					
		RP-LBI-G1-2F-9W-DOXK-WC-[BAA]-3X	3	35K/ <b>40K/50K</b>	9	1285	27	3855					
		RP-LBI-G1-2F-9W-DOXK-WC-HV-[BAA]-3X	3	35K/ <b>40K/50K</b>	9	1285	27	3855					
		RP-LBI-G1-2F-12W-DOXK-WC2-[BAA]-3X	3	<b>27K/30K/35K</b>	12	1480	36	4440					
		RP-LBI-G1-2F-12W-DOXK-WC2-HV-[BAA]-3X	3	<b>27K/30K/35K</b>	12	1480	36	4440					
		RP-LBI-G1-2F-12W-DOXK-WC-[BAA]-3X	3	35K/ <b>40K/50K</b>	12	1600	36	4800					
		RP-LBI-G1-2F-12W-DOXK-WC-HV-[BAA]-3X	3	35K/ <b>40K/50K</b>	12	1600	36	4800					
	3FT	RP-LBI-G1-3F-10W-DOXK-WC2-[BAA]-3X	3	<b>27K/30K/35K</b>	10	1268	30	3804					
		RP-LBI-G1-3F-10W-DOXK-WC2-HV-[BAA]-3X	3	<b>27K/30K/35K</b>	10	1268	30	3804					
		RP-LBI-G1-3F-10W-DOXK-WC-[BAA]-3X	3	35K/ <b>40K/50K</b>	10	1434	30	4302					
		RP-LBI-G1-3F-10W-DOXK-WC-HV-[BAA]-3X	3	35K/ <b>40K/50K</b>	10	1434	30	4302					
		RP-LBI-G1-3F-12W-DOXK-WC2-[BAA]-3X	3	<b>27K/30K/35K</b>	12	1522	36	4566					
		RP-LBI-G1-3F-12W-DOXK-WC2-HV-[BAA]-3X	3	<b>27K/30K/35K</b>	12	1522	36	4566					
		RP-LBI-G1-3F-12W-DOXK-WC-[BAA]-3X	3	35K/ <b>40K/50K</b>	12	1761	36	5283					
		RP-LBI-G1-3F-12W-DOXK-WC-HV-[BAA]-3X	3	35K/ <b>40K/50K</b>	12	1761	36	5283					
		RP-LBI-G1-3F-15W-DOXK-WC2-[BAA]-3X	3	<b>27K/30K/35K</b>	15	1855	45	5565					
		RP-LBI-G1-3F-15W-DOXK-WC2-HV-[BAA]-3X	3	<b>27K/30K/35K</b>	15	1855	45	5565					
		RP-LBI-G1-3F-15W-DOXK-WC-[BAA]-3X	3	35K/ <b>40K/50K</b>	15	2000	45	6000					
		RP-LBI-G1-3F-15W-DOXK-WC-HV-[BAA]-3X	3	35K/ <b>40K/50K</b>	15	2000	45	6000					
4FT	RP-LBI-G1-4F-10W-DOXK-WC2-[BAA]-3X	3	<b>27K/30K/35K</b>	10	1265	30	3795						
	RP-LBI-G1-4F-10W-DOXK-WC2-HV-[BAA]-3X	3	<b>27K/30K/35K</b>	10	1265	30	3795						
	RP-LBI-G1-4F-10W-DOXK-WC-[BAA]-3X	3	35K/ <b>40K/50K</b>	10	1462	30	4386		PK6W04ZH		P		
	RP-LBI-G1-4F-10W-DOXK-WC-HV-[BAA]-3X	3	35K/ <b>40K/50K</b>	10	1462	30	4386						
	RP-LBI-G1-4F-15W-DOXK-WC2-[BAA]-3X	3	<b>27K/30K/35K</b>	15	1895	45	5685						
	RP-LBI-G1-4F-15W-DOXK-WC2-HV-[BAA]-3X	3	<b>27K/30K/35K</b>	15	1895	45	5685						
	RP-LBI-G1-4F-15W-DOXK-WC-[BAA]-3X	3	35K/ <b>40K/50K</b>	15	2130	45	6390		PMR4JX86		P		
	RP-LBI-G1-4F-15W-DOXK-WC-HV-[BAA]-3X	3	35K/ <b>40K/50K</b>	15	2130	45	6390						
	RP-LBI-G1-4F-25W-DOXK-WC2-[BAA]-3X	3	<b>27K/30K/35K</b>	25	3160	75	9480						
	RP-LBI-G1-4F-25W-DOXK-WC2-HV-[BAA]-3X	3	<b>27K/30K/35K</b>	25	3160	75	9480						
	RP-LBI-G1-4F-25W-DOXK-WC-[BAA]-3X	3	35K/ <b>40K/50K</b>	25	3650	75	10950		P8M1MF5Q		P		
	RP-LBI-G1-4F-25W-DOXK-WC-HV-[BAA]-3X	3	35K/ <b>40K/50K</b>	25	3650	75	10950						



To order for continuous runs, please order "1 Bar Kits" + required accessory connectors (sold separately).  
 Connect up to 40 light bars on one incoming power cable.

All models on the DLC QPL are premium listed.

### BASE VERSION (4FT, 1X BAR KIT) - 15W ONLY

PART #	UPC	DESCRIPTION	WATTAGE	LUMENS	LPW	CCT (K)	DLC PRODUCT CODE
RP-LBI-G1-4F-15W-40K-B	844006024215	4FT BASE INTERNAL DRIVE LIGHT BAR	15	1996	139	4000	PMROEESV

### STAIRWELL FIXTURE

PART #	UPC	DESCRIPTION	WATTAGE	LUMENS	LPW	CCT (K)	DLC PRODUCT CODE
RP-LBI-G1-2F-12W-40K-W-OC2	844006024505	2FT INTERNAL DRIVE LIGHT BAR STAIRWELL KIT	12	1560	130	4000	P3QQVAJH
RP-LBI-G1-4F-15W-40K-W-OC2	844006024512	4FT INTERNAL DRIVE LIGHT BAR STAIRWELL KIT	15	2055	137	4000	PS1Q17X9

Kit comes with 1X light bar + OC2 Motion Sensor Kit.



LIGHT EFFICIENT DESIGN HEADQUARTERS 188 S. Northwest Highway • Cary, IL 60013  
 INNOVATION & MANUFACTURING CENTER 30 Log Bridge Road, Building 200 • Middleton, MA 01949  
 847.380.3540 • led-llc.com

# —○ LEDBarKit-Internal Driver (LBI)

## APPLICATION TABLE OF CONTENTS

PARTS & ACCESSORIES .....	PAGE 10
RETROFIT TROFFERS .....	PAGE 11
RETROFIT LINEAR FIXTURES .....	PAGE 12
CONTINUOUS RUN FIXTURES / RETROFIT .....	PAGE 13
HIGH BAY FIXTURE / RETROFIT .....	PAGE 14
STAIRWELL FIXTURE KIT / UTILITY FIXTURE.....	PAGE 15

### IMPORTANT NOTE ON WIRING METHOD

As you will see on the following pages, there are many possible uses for The Linear Transformer. If your application calls for multiple light bars in a single fixture, there are 2 possible ways to order and wire (see below).

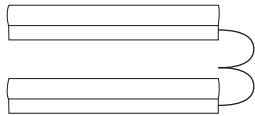

#### PARALLEL

Multiple incoming power cables can be grouped together under the ballast cover to make connection to incoming power and controls.

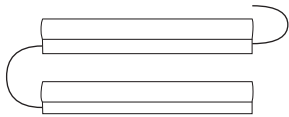

#### SERIES (WITH LINKING CABLE)

This method is the fastest. The first light bar uses an incoming power cable, additional light bars are linked using "linking cables" which are available in a variety of lengths. Linking cables are sold separately.

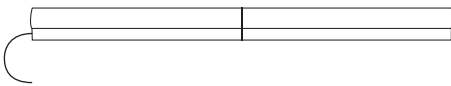

#### SERIES (WITH SEAMLESS CONNECTOR)

This method provides a near seamless appearance between the bars. The first light bar uses an incoming power cable, additional light bars are linked using "seamless connectors" which are sold separately.



# RP-LBI-EMG1-25W (SINGLE FLEX)

# RP-LBI-EMG2-25W (DUAL FLEX)

## PRODUCT DESCRIPTION

The EMG-H Series LED emergency drivers are UL Listed for factory or field installation, unrivaled emergency solutions for LED product with internal driver. It allows the same LED luminaire to be used for normal and emergency operation and works in conjunction with an AC LED driver that convert new or existing LED fixtures into emergency lighting. It includes a long-life recyclable Lithium battery, and is backed by a 5-Year Warranty.

## OPERATION

When AC power fails, The EM-H Series emergency LED driver immediately switches to the emergency mode, operating the LEDs at full lumen output for a minimum of 90 minutes (25W max load). When AC power is restored, the emergency driver automatically returns to the charging mode.

## FEATURES

1. Long life recyclable Lithium battery.
2. Integration of test switch and charge indicator.
3. Used for exterior or interior of luminaire.
4. The power of LED luminaire < power of emergency driver.

## MOUNTING CONFIGURATION:

### RP-LBI-EMG1-25W Single Flex (Standard Version)

Mounts to the junction box and provides flexible conduit for remote mounting of the test accessories.

### RP-LBI-EMG2-25W Dual Flex (Optional)

Provides dual flex for wiring to both fixture or driver compartment and test accessories



## TYPICAL WIRING DIAGRAM

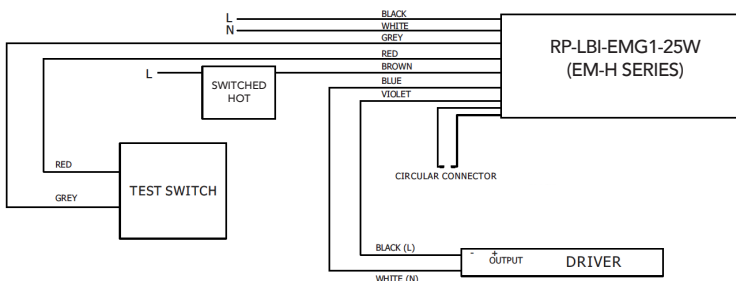

## EM-H Series

### UL Listed LED Emergency Driver

Unrivaled emergency solutions for LED Products with Internal drivers



## DIMENSIONS

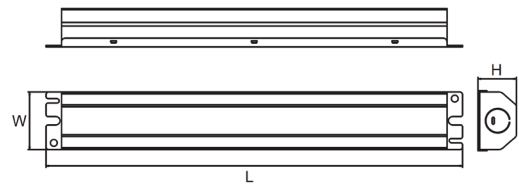

MODEL	L	W	H
EM-H25170-XX	17.14"	2.13"	1.57"

### RP-LBI-EMG1-25W (EM-H25170-XX)



- Output Power**  
25 Watts (Max Load)
- Output Voltage**  
170V DC
- Input Current**  
60 mA (Max)
- Input Power**  
8 Watts (Max)
- Input Volatage**  
120-277VAC, 50-60Hz
- Emergency Operation**  
>90 Minutes
- Operating Temp**  
0° to 50°C
- Battery**  
Lithium
- Recharge**  
36 Hrs
- Dimensions**  
L 17.14' X W 2.13" X H 1.57"



# LEDBarKit-Internal Driver (LBI)

## PARTS & ACCESSORIES

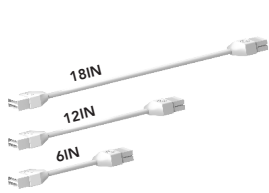

### LINKING CABLES

RP-LBI-LC-6IN-DIM-10P  
RP-LBI-LC-6IN-NODIM-10P  
  
RP-LBI-LC-12IN-DIM-10P  
RP-LBI-LC-12IN-NODIM-10P  
  
RP-LBI-LC-18IN-DIM-10P  
RP-LBI-LC-18IN-NODIM-10P

### INCOMING POWER KIT: RP-LBI-G1-IP-3F-DIM

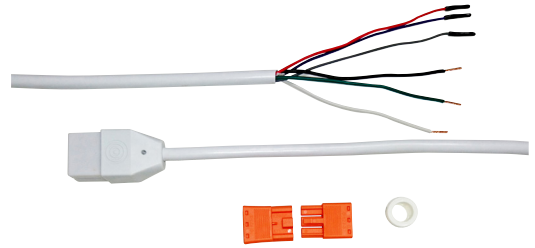

### DIM



### SEAMLESS CONNECTOR

RP-LBI-SSC-DIM-10P  
RP-LBI-SSC-NODIM-10P

### NO-DIM



### LINKING CABLES & SEAMLESS CONNECTORS

Use Linking Cables and Seamless Connectors to easily connect the power and control wires from one light bar to another. The ...-DIM version of the linking cables and seamless connector link all connections (AC power; 12V Aux power; 0-10V DIM signal) from light bar to light bar. Use these items to control all light bars from one sensor or incoming cable connection. The ...-NODIM version of these items only links the AC power. Use these items to AC power all light bars with a single power feed; but separate control signals into individual groups.



### 4.7IN SPACER CONNECTOR | RP-LBI-SRC-4.7IN (SINGLE PACK)

Use the 4.7in Spacer Connector to bring the length of the bar system to a standard dimension (24in, 36in, 48in). This is useful when retrofitting linear fixtures of a standard length. It allows for the bar to be centered on each standard-length fixture. Each 4.7in spacer connector comes with (2) Seamless Connector-DIM.

**\*Note: spacer does not emit light**



### OC2 SENSOR KIT | RP-LBI-OC2 (SINGLE PACK)

Sensor OC2 is a Tri-Level, remote controllable high frequency sensor designed to easily integrate with the light bars. It is totally plug&play! It can dim the light bars down to conserve more energy from both motion and daylight. The OC2 sensor controls the 0-10V DIM signal in both directions from the Sensor unit. Each sensor kit comes with (1) OC2 sensor (4.7 inch); (1) surface mount magnetic clip; (2) Seamless Connector-DIM; (1) 12" Linking Cable-DIM. See *RP-LBI-OC2 data sheet* for more details.



### SURFACE MOUNT MAGNETIC CLIP | RP-LBI-SMM-10P (10 PACK ONLY)

The Surface Mount Magnetic Clip provides the most universal method for attaching the light bar to a wall, ceiling, or fixture to be retrofitted. The mounting tabs that extend perpendicularly from the light bar can be easily removed by bending and breaking on the pre-scored line. The strong rare-earth magnets are intended to hold light bars in place while installing mechanical fasteners. Not intended for permanent installation with magnets only.

*Two of these clips are included in each light bar kit.*



### SUSPENDED IN-LINE BRACKET KIT | RP-LBI-SIL-KIT-10P (10 PACK ONLY)

The Suspended In-Line Bracket is a wide clip that fastens over the junction of 2 light bars to keep them straight in-line and provides mounting points for common suspension methods (air craft cable, drop chain, etc.) Cable = 9.8 feet

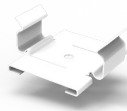

### T-BAR CLIP | RP-LBI-T1516-10P (10 PACK ONLY)

The T-Bar Clip is the fastest way to mount a light bar to a T-Bar grid ceiling. Works with standard 15/16" grid only.



### BLADE CLIP | RP-LBI-BLC-10P (10 PACK ONLY)

The Blade Clip is designed to provide a retrofit solution for fixtures that have thin sheet metal or plastic film reflectors commonly found on high bay fixtures. The rotating mounting blade provides a degree of freedom to align the mounting holes on the blade with fastening locations that may not be in-line with the light bar or where the distance between available mounting points is greater than the length of the light bar. It is common to attach the blade to the same point holding the thin reflector to the fixture frame.

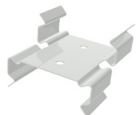

### UP/DOWN CLIP | RP-LBI-UDC-10P (10 PACK ONLY)

Use the Up/Down clip with our suspended in-line kit to clip a shorter bar to provide up-light. For example if suspending a 4ft, use the 3ft OR 2ft as the up-light, (so there is room for the suspension-kit connection). The RP-LBI-



# LEDBarKit-Internal Driver (LBI)

SUSPENDED IN LINE KIT\*

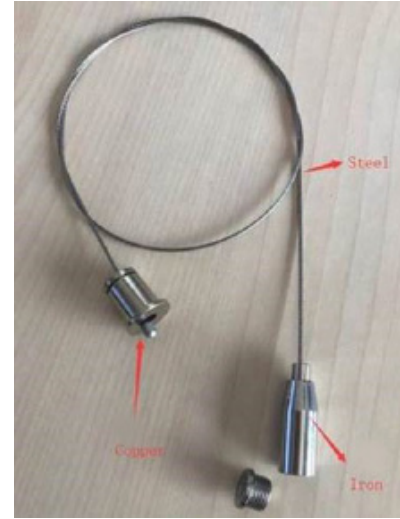

## RECOMMENDED INSTALLATION

### CONTINUOUS RUN

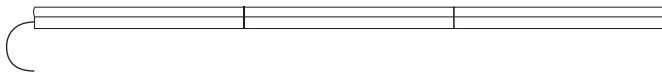

### CONTINUOUS RUN WITH OPTIONAL OC2 SENSOR KIT

OC2 Sensor can be installed on either end or in between any bars

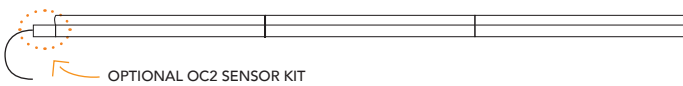

OPTIONAL OC2 SENSOR KIT



OPTIONAL OC2 SENSOR KIT

### CONTINUOUS RUN WITH SPACER CONNECT

Ideal for retrofitting fixtures of standard length

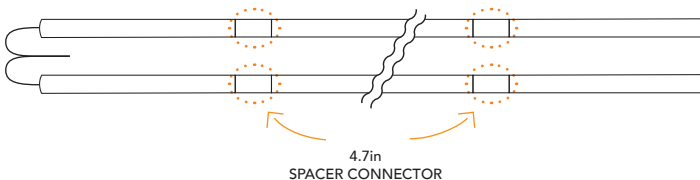

4.7in  
SPACER CONNECTOR

## DIMENSIONS

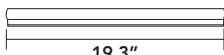

19.3"

RP-LBI-G1-2F-...

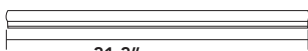

31.3"

RP-LBI-G1-3F-...

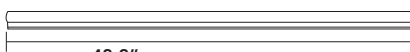

43.3"

RP-LBI-G1-4F-...

\*When calculating continuous run, note that actual lengths are less than what is stated in the part number.

## ACCESSORIES

### SEAMLESS CONNECTOR\*

RP-LBI-SSC-DIM (sold separately)

Links the OCC control signal to all bars.

RP-LBI-SSC-NODIM (sold separately)

Isolates each OCC control group within the continuous run.

\*All continuous run installations require seamless connectors.



### SUSPENDED IN-LINE BRACKET KIT

RP-LBI-SIL (sold separately)

Recommended qty = number of bars + 1

### LINKING CABLES\*

RP-LBI-LC-6IN-DIM

RP-LBI-LC-6IN-NODIM

RP-LBI-LC-12IN-DIM

RP-LBI-LC-12IN-NODIM

RP-LBI-LC-18IN-DIM

RP-LBI-LC-18IN-NODIM

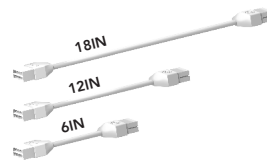

\* Choose the appropriate linking cable length based on the dimensions of your fixture.



LIGHT EFFICIENT DESIGN HEADQUARTERS 188 S. Northwest Highway • Cary, IL 60013  
INNOVATION & MANUFACTURING CENTER 30 Log Bridge Road, Building 200 • Middleton, MA 01949  
847.380.3540 • led-llc.com

# LEDBarKit-Internal Driver (LBI)

## RETROFIT TROFFERS\*

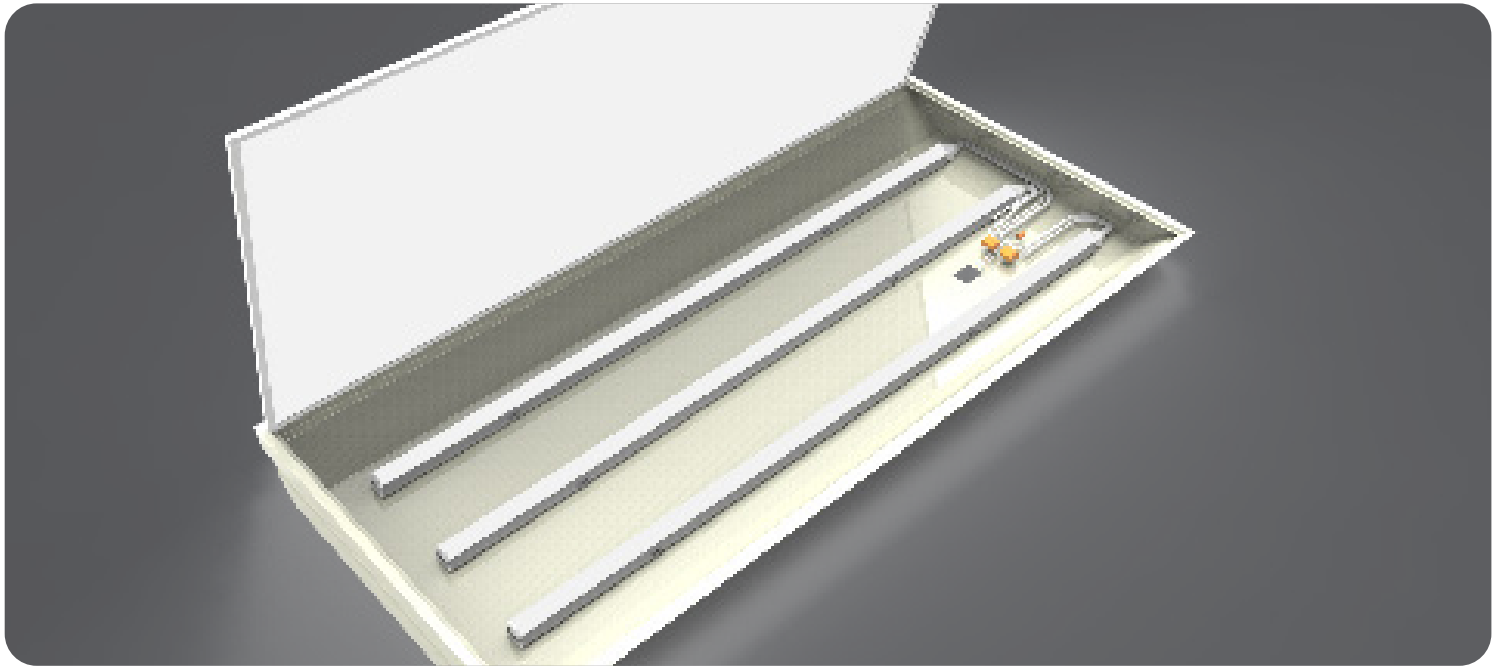

### RECOMMENDED INSTALLATION

### ACCESSORIES

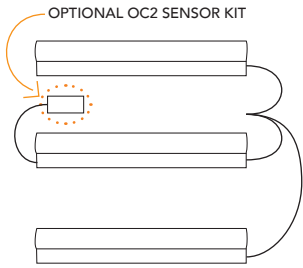

#### PARALLEL

This method is the most cost effective. Each light bar comes with its own incoming power cable. Multiple incoming power cables are connected together under the ballast cover.

#### INCOMING POWER CABLES

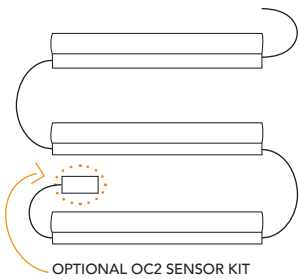
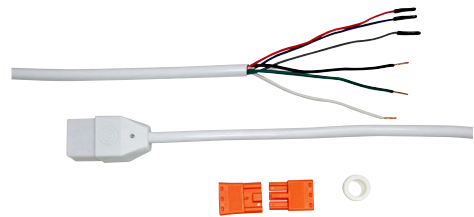

#### SERIES

This method is the fastest. The first light bar uses an incoming power cable, additional light bars are linked using "linking cables" which are available in a variety of lengths. Linking cables are sold separately.

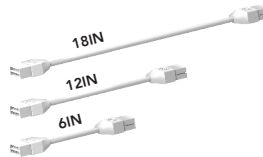

#### LINKING CABLES\*

- RP-LBI-LC-6IN-DIM
- RP-LBI-LC-6IN-NODIM
- RP-LBI-LC-12IN-DIM
- RP-LBI-LC-12IN-NODIM
- RP-LBI-LC-18IN-DIM
- RP-LBI-LC-18IN-NODIM

\* Choose the appropriate linking cable length based on the dimensions of your fixture.



# LEDBarKit-Internal Driver (LBI)

## RETROFIT LINEAR FIXTURES \*

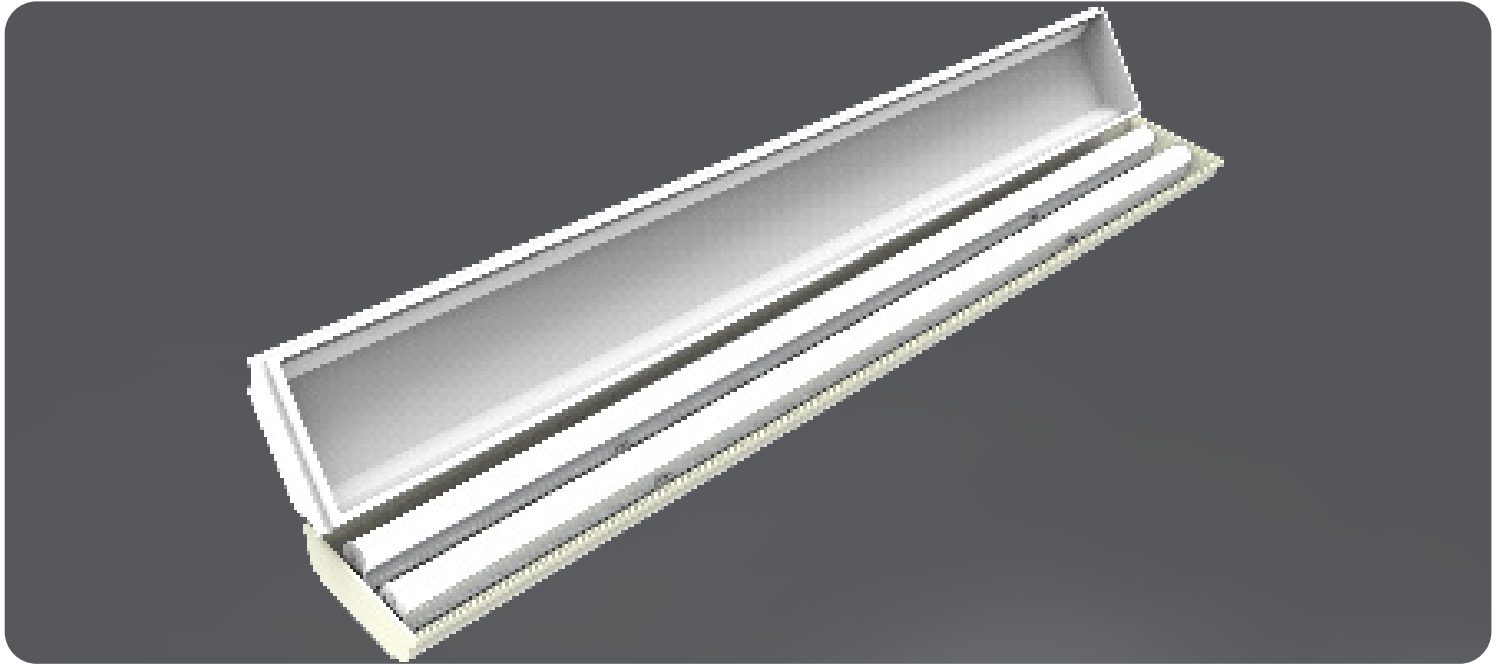

\* Example Retrofit. Fixture not included.

### RECOMMENDED INSTALLATION

#### PARALLEL

Multiple incoming power cables are connected together under the ballast cover.

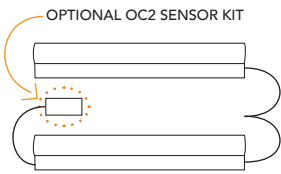

### ACCESSORIES

#### INCOMING POWER CABLES

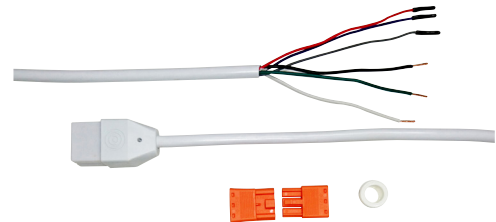

#### SERIES

This method is the fastest. The first light bar uses an incoming power cable, additional light bars are linked using "linking cables" which are available in a variety of lengths.

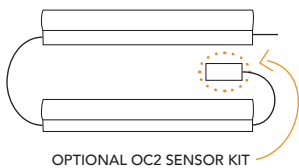

#### LINKING CABLES\*

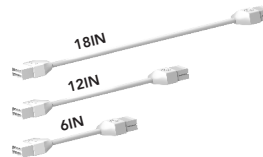

- RP-LBI-LC-6IN-DIM
- RP-LBI-LC-6IN-NODIM
- RP-LBI-LC-12IN-DIM
- RP-LBI-LC-12IN-NODIM
- RP-LBI-LC-18IN-DIM
- RP-LBI-LC-18IN-NODIM

\* Choose the appropriate linking cable length based on the dimensions of your fixture.



# LEDBarKit-Internal Driver (LBI)

CONTINUOUS RUN FIXTURES / RETROFIT\*

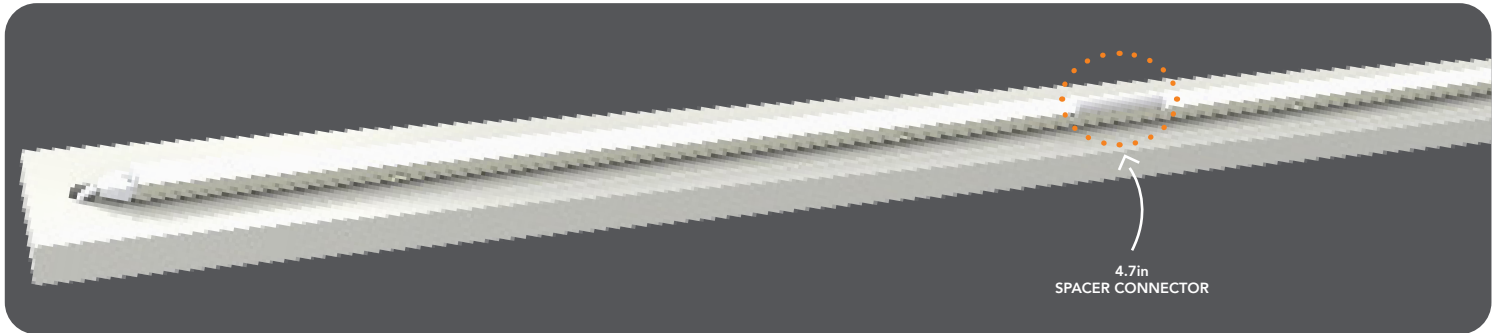
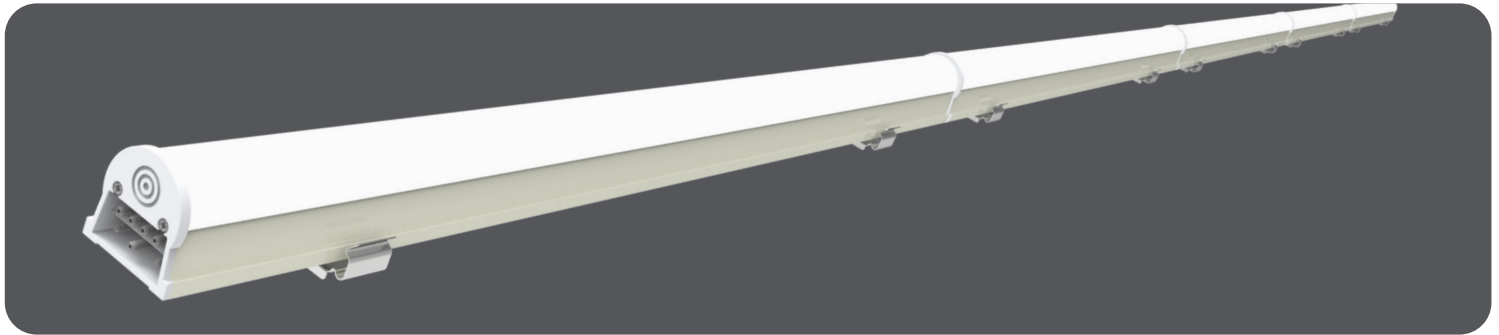

\* Example Retrofit. Fixture not included.

## RECOMMENDED INSTALLATION

### CONTINUOUS RUN

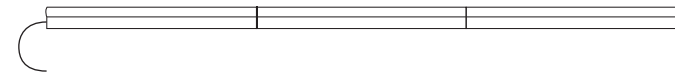

### CONTINUOUS RUN WITH OPTIONAL OC2 SENSOR KIT

OC2 Sensor can be installed on either end or in between any bars

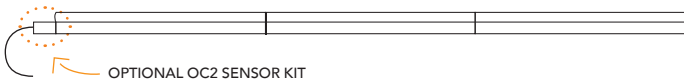

### CONTINUOUS RUN WITH SPACER CONNECT

Ideal for retrofitting fixtures of standard length

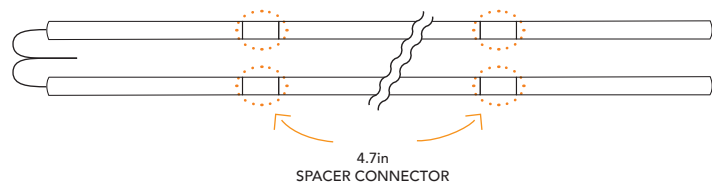

## DIMENSIONS

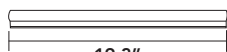

19.3"  
RP-LBI-G1-2F...

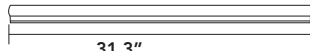

31.3"  
RP-LBI-G1-3F...



43.3"  
RP-LBI-G1-4F...

\*When calculating continuous run, note that actual lengths are less than what is stated in the part number.

## ACCESSORIES

### SEAMLESS CONNECTOR\*

RP-LBI-SSC-DIM (sold separately)  
Links the OCC control signal to all bars.  
RP-LBI-SSC-NODIM (sold separately)  
Isolates each OCC control group within the continuous run.

\*All continuous run installations require seamless connectors.

### SURFACE MOUNT MAGNETIC CLIP

RP-LBI-SMM (2x included with bar)

### SUSPENDED IN-LINE BRACKET KIT

RP-LBI-SIL (sold separately)  
Recommended qty = number of bars + 1

### T-BAR CLIP

RP-LBI-T1516 (sold separately)  
Recommended qty = 2x per bar

### 4.7in SPACER CONNECTOR

RP-LBI-SRC-4.7IN (sold separately)

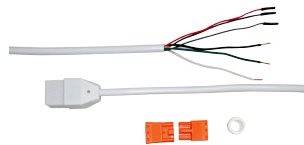
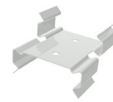
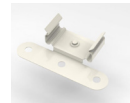

### INCOMING POWER CABLES

\*Connect up to 40 units on one incoming power cable



LIGHT EFFICIENT DESIGN HEADQUARTERS 188 S. Northwest Highway • Cary, IL 60013  
INNOVATION & MANUFACTURING CENTER 30 Log Bridge Road, Building 200 • Middleton, MA 01949  
847.380.3540 • led-llc.com

# —○ LEDBarKit-Internal Driver (LBI)

## HIGH BAY FIXTURE / RETROFIT\*

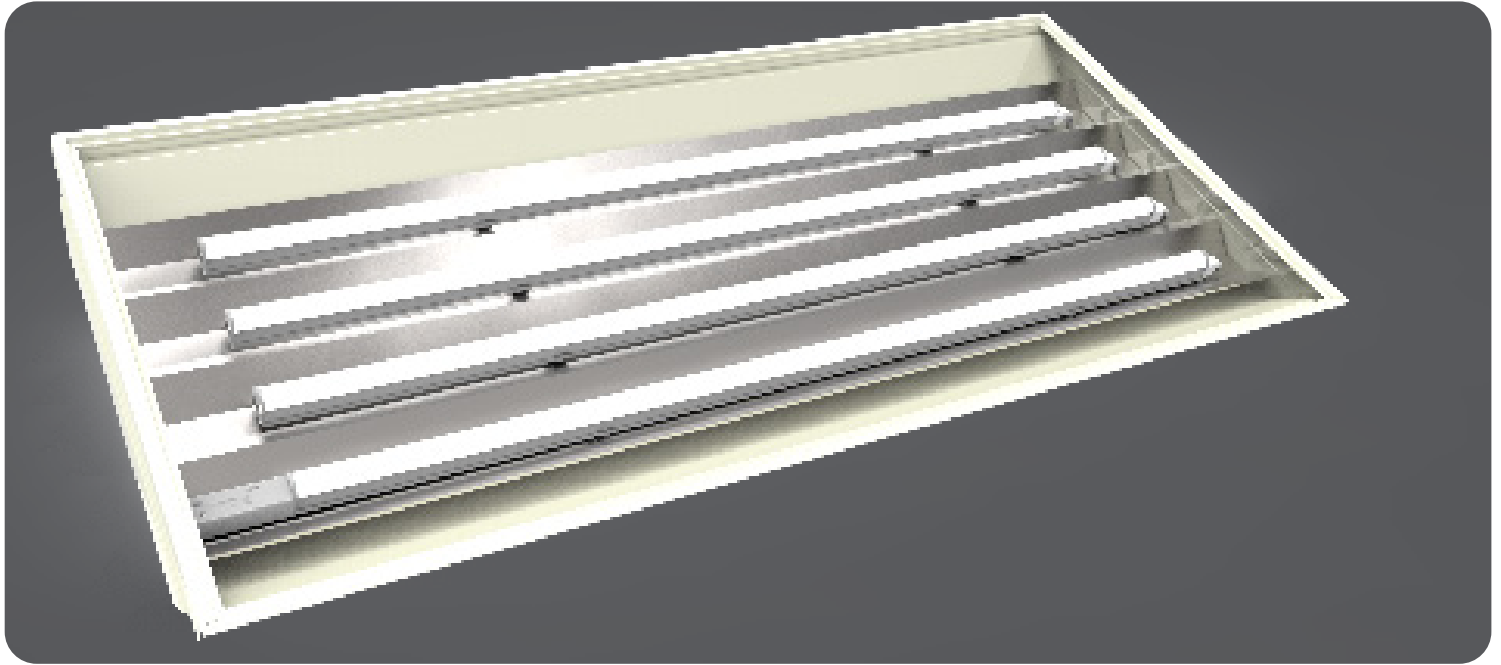

\* Example Retrofit. Fixture not included.

### RECOMMENDED INSTALLATION

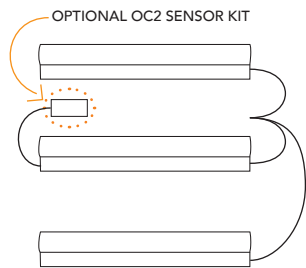

#### PARALLEL

This method is the most cost effective. Each light bar comes with its own incoming power cable. Multiple incoming power cables are connected together under the ballast cover.

### ACCESSORIES

#### BLADE CLIP

RP-LBI-BLC-10P

The Blade Clip is designed to provide a retrofit solution for fixtures that have thin sheet metal or plastic film reflectors commonly found on high bay fixtures. It is common to attach the blade to the same point holding the thin reflector to the fixture frame.

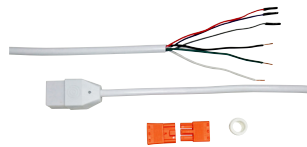

#### INCOMING POWER CABLES

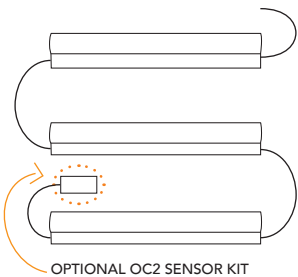

#### SERIES

This method is the fastest. The first light bar uses an incoming power cable, additional light bars are linked using "linking cables" which are available in a variety of lengths. Linking cables are sold separately.

#### LINKING CABLES\*

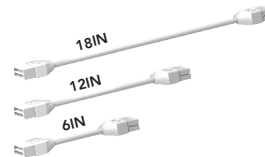

RP-LBI-LC-6IN-DIM  
RP-LBI-LC-6IN-NODIM  
RP-LBI-LC-12IN-DIM  
RP-LBI-LC-12IN-NODIM  
RP-LBI-LC-18IN-DIM  
RP-LBI-LC-18IN-NODIM

\* Choose the appropriate linking cable length based on the dimensions of your fixture.

Light Bars are DLC listed under the high bay fixture category. You can choose to purchase Light Bars only and hang/mount as a standalone fixture or retrofit an existing high bay fixture housing as shown above.



LIGHT EFFICIENT DESIGN HEADQUARTERS 188 S. Northwest Highway • Cary, IL 60013  
INNOVATION & MANUFACTURING CENTER 30 Log Bridge Road, Building 200 • Middleton, MA 01949  
847.380.3540 • led-llc.com

# LEDBarKit-Internal Driver (LBI)

## STAIRWELL FIXTURE KIT / UTILITY FIXTURE\*

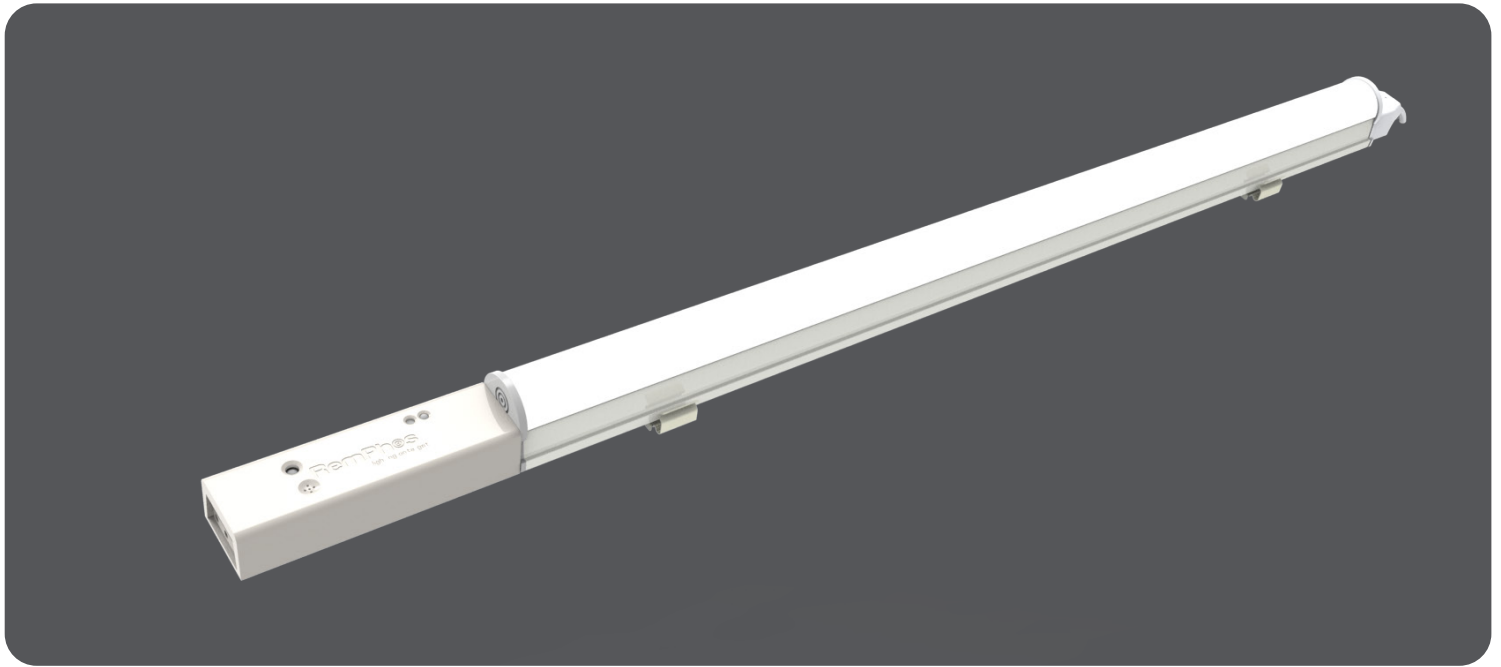

\* Example Retrofit. Fixture not included.

### STAIRWELL FIXTURE KIT INCLUDES



#### ORDERING #

2FT: RP-LBI-2F-12W-40K-W-OC2  
4FT: RP-LBI-4F-15W-40K-W-OC2

1 - INCOMING POWER CABLE

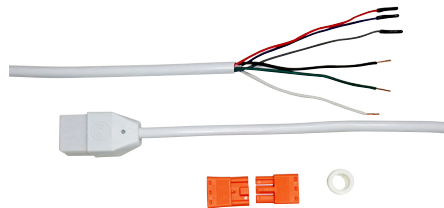

#### 1 - OC2 SENSOR KIT

RP-LBI-OC2  
Sensor + Seamless Connector-DIM

### UTILITY FIXTURE

To use as a standalone utility fixture, purchase 1X Light Bar kit and 1X incoming power cable kit.

Fixture housings to be used as wiring and emergency battery compartment currently in development. Call for more information.



LIGHT EFFICIENT DESIGN HEADQUARTERS 188 S. Northwest Highway • Cary, IL 60013  
INNOVATION & MANUFACTURING CENTER 30 Log Bridge Road, Building 200 • Middleton, MA 01949  
847.380.3540 • led-llc.com

# RP-LBI-OC2 SENSOR KIT FOR LEDBARKIT - INTERNAL DRIVER (LBI)

## Remote Control Settings

If satisfied with OC2 default settings, remote control is not needed. If settings need to be changed, optional remote control (RP-OC2-REMOTE-IR11), is required.



### PERMANENT ON FUNCTION

Press 'ON' button, fixture goes to permanent on mode, sensor is disabled. With memory function against power failure.

\* Press 'Auto' or 'Reset' to quit this mode.



### PERMANENT OFF FUNCTION

Press 'OFF' button, fixture goes to permanent off mode, sensor is disabled.

\* Press 'Auto' or 'Reset' learn' to quit this mode.



### SENSOR MODE

Press 'Auto' button, the sensor starts to work and all settings remain the same as the latest status before the light was switched on/off.



### RESET FUNCTION

Press 'Reset' button, all settings go back to factory default settings.

### FACTORY DEFAULT SETTINGS - REMOTE REQUIRED TO CHANGE SETTINGS

- Sensitivity=50%
- Daylight sensor=disable
- Hold time=5min
- Twilight time=+∞
- Twilight level=30%

**NOTE** daylight harvest function is disabled in factory default mode. Choose the appropriate lux threshold first to activate the daylight harvest function.



### DISABLE DAYLIGHT SENSOR

Press 'Disable' button, the daylight sensor will be disabled, the motion sensor will work always, even in daytime.



### TEST MODE

'Test mode' is used for testing purpose only, for users to check the the desired detection range.

Quit test mode by pressing any other button of 'Hold time'. The sensor settings are changed accordingly.

### TEST MODE SETTINGS

- Daylight sensor=disable
- Hold time=3s
- Twilight time=N/A
- Twilight level=N/A



IR11

- The buzzer short beeps (~0.5s) ONCE when sensor successfully receives RC signal after pressing any button.
- When "twilight level" set at 0%, it becomes ON/OFF control.
- The sensor controls the LBI fixtures w/ 0-10V inputs. Even if on/off only function is desired, the OC2 sensor is only compatible w/ PRO series LBI products. (Not compatible w/ LBI Base series)

